

**audioquest®**

---

**EURO RETAIL  
PRICE BOOK**

**OCTOBER 1, 2022**



# TABLE OF CONTENTS

## USB Digital-Audio Converters

DragonFly DACs	5
JitterBug FMJ USB Noise Filter	5
USB Extenders and Adaptors	5

## AC Power

Power Conditioners	7
Power Cables	9–10
Power Plugs	10
Wall Outlets	12
Adaptors	12
Fog Lifters (Cable Risers)	12

## Speaker Cables

Q2	16
Type Series	16
Rocket Series	17
Folk Heroes	18–19
Mythical Creatures	20–22
BiWire Jumpers	23
Fog Lifters (Cable Risers)	23
Binding Post Wrench	23

## Audio Interconnect Cables

Bridges & Falls	25
Rivers & Mythical Horses	26
Mythical Creatures	27
Adaptors, Splitters, Couplers	28
PreAmp Jumpers	28

## Subwoofer Cables

29

## Tonearm & Turntable Cables

31

## Vinyl Accessories

GroundGoody Tonearm & Ground Wires	33
Record Brushes	33

## Headphone Accessories

Headshell Leads	33
NightBird Headphone Cable	33
Headphone Plug Adaptor	33
Perch Headphone Stand	33

## HDMI Cables

8K (48Gbps)	36
4K (18Gbps) & 8K (48Gbps) Long-Length	37
8K (48Gbps) eARC-Priority	37
Adaptors, Coupler	38

## Digital-Audio Interconnect Cables

USB Cables and Adaptors	40–41
Optical Cables and Adaptor	42
Digital Coax Cables and Adaptor	43
AES/EBU (Balanced) Cables	44
Ethernet Cables (RJ/E)	45

## Accessories

DBS Pack	46
Q-Foot System	46
Fog Lifters (Cable Risers)	46
CleanScreen	46
Sorbothane Self-Stick Sheet	46
Binding-Post Wrench	46
Adaptors, Splitters, Couplers	47
Antenna Cables - HD6 Forest	47
RCA, XLR, Coax	
Plugs and Connectors	48
Noise-Stopper Caps	49

## Tools

Crimp Tools, Cable Cutters, and Wire Strippers	50
Silver Solder	50

## Instant Tool-less Connectors (ITC)

Cable Stripper	51
Bulk Cables	51
Connectors	51

## Bulk Speaker Cables (Spools)

CL3/FT4 In-Wall Rated Speaker Cables	52
Speaker Cables — Not In-Wall Rated	53
SureGrip® Speaker Connectors	54
Spade, Pin, and Banana Connectors	55
Termination Pants	55

## Bulk Audio Interconnect Cables (Spools)

CL3/FT4 In-Wall Rated Audio Interconnect Cables and Plugs	56
--	----

## Bulk Ethernet Cables (Spools)

CL3/FT4 In-Wall Rated CAT6 and CAT7 Ethernet Cables & Plugs	57
--	----

## Installer Packs

Cables, Splitters and Adaptors in Single, Packs of 5 and 10	58–59
--	-------

## POP Materials

Wall Signs, Tent Card, Window Sticker	60
Spool Holder	60
In-Store Display Racks	60

## Promotional Items

Polo, T-shirt, Jacket	61
Baseball Cap, Beanie	61
Pen	61
Tumbler, Water Bottle	61
License Plate Frame	62
Backpacks, Tote Bag	62

## Index

63–64

## Terms and Conditions

- Prices are subject to change without notice.
- All prices are in Euro.
- As used throughout this price book, "Retail" carries the same meaning as Suggested Retail Price (SRP).

## Returns

- All returns are subject to approval by AudioQuest.
- Built-to-order products may not be returned.
- All sales are final for custom speaker cables produced at 2m or less.
- A Return Merchandise Authorization (RMA) number must be issued by AudioQuest before any product may be returned.
- The RMA number must appear on the outside of the shipping carton, near or on the address label.

## Contact Information

AudioQuest  
Hoge Bergen 10  
4704 RH Roosendaal  
The Netherlands  
www.audioquest.com  
Tel: +31 165 54 1404

Email orders and related correspondence: [orders@audioquest.nl](mailto:orders@audioquest.nl)

Email all other correspondence to: [info@audioquest.nl](mailto:info@audioquest.nl)

Copyright © 2022 AudioQuest.

All rights reserved.

E & OE. In the interests of continuous product improvement, all specifications are subject to change without notice.

## AudioQuest: Doing No Harm Since 1980



**William (Bill) Low**  
Founder / CEO

For 40 years now, AudioQuest, headquartered in Irvine, California, has been a leading developer, manufacturer, and distributor of high-performance audio/video products and custom-install solutions. Although best known for our comprehensive range of analog, digital, and AC power cables, our portfolio has expanded to a diverse assortment of products, including the multi-award-winning DragonFly DACs, LYRA, and Niagara and PowerQuest power products.

Our ultimate goal is the same today as it was 40 years ago: Do No Harm! By this we mean that all cables and components, to the extent that is technologically feasible, should get out of the music's way by inducing the least amount of noise and distortion.

### The Evolution Continues: The Four Elements Today

While minimizing noise and damage to the audio signal remains the North-Star constant, the ways in which AudioQuest engages these challenges always evolves. While there are still Four Elements that describe our foundational materials and design philosophies, a growing number of technologies cross and even go beyond our original Four Elements. Many have become crucial enough to demand visibility. Noise-Dissipation is an umbrella Element under which many of these meaningful techniques and technologies will reside. While Geometry is no longer identified as one of The Four Elements, it remains inextricably tied to all other Elements of cable design and manufacture.

**Solid Conductors:** Strand interaction remains the biggest potential source of distortion in cables. Solid Conductors are the aspirational ideal and most complete solution to this problem. However, thoughtfully arranged multi-conductor geometries such as concentric windings are used to create our Semi-Solid Conductor technologies. These avoid many strand-distortion mechanisms and are in their own right ideal in a growing number of applications.

**Directionality:** All drawn metal conductors have a non-symmetrical, fish-scale-like grain structure. Because the highest Radio Frequencies (RF) are subject to skin effect, traveling on this deformed outer-surface layer of the conductor, there is a resulting increase in RF impedance in one direction versus the other. Since induced RF noise is parasitic (and doesn't travel with the primary signal current), it takes the path of least resistance. At AudioQuest, we test every conductor so it is used in the direction that drains the induced noise away from where it will cause the most harm, optimizing the cable and the system's performance.

**Noise-Dissipation:** Unwanted Radio-Frequency (RF) noise is and has always been picked up and induced into cable. This contamination ultimately masks and distorts critical portions of the audio/video signal. As this distortion-causing (parasitic) RF signal is more present today than at any previous time in history, we must depend on a wider arsenal of Noise-Dissipation technologies:

- ZERO-Tech (No Characteristic Impedance) applies Ultra-Linear Noise-Dissipation across the widest range of frequencies possible. It also enables uncompressed transient current transfer for AC power and loudspeaker/power amplifier applications.
- RF/ND-Tech (Patented Radio-Frequency Ground-Noise Dissipation) minimizes circuit misbehavior by cancelling induced RF noise.
- Tried-and-true DBS (Dielectric-Bias System) has evolved to include RF-Noise Traps that further reduce dielectric distortion and induced noise.

**Metal Quality:** Higher-purity conductor metals with smoother surfaces and internal crystal structures greatly reduce noise and distortion. Carefully finessed mixes of metals and conductor sizes can be effectively used to define a cable's Sonic Signature—a cost-effective technique for high-value, high-performance models.

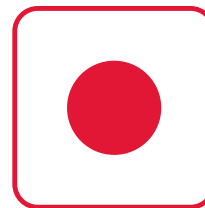

Solid Conductors

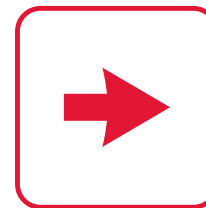

Directionality

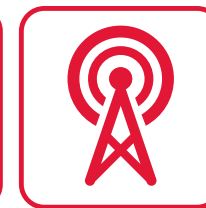

Noise-Dissipation

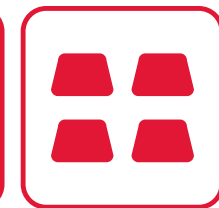

Metal Quality

# DragonFly

## Naturally Beautiful Sound at Your Fingertips—Whenever and Wherever You Want It

With today's smartphones, tablets, and computers, music and videos are far more accessible than ever before.

Unfortunately, the digital-to-analog converters (DACs) inside these devices are highly compromised, even when the sample-rate numbers (24/192, etc.) look impressive. These built-in DACs may make audible sound, but they don't make beautiful music.

A DragonFly bypasses the compromised audio circuitry within these devices to deliver naturally beautiful sound to earbuds, headphones, desktop speakers, or complete audio systems.

Whether using a free streaming service, premium High-Resolution or MQA-encoded streaming (such as Tidal Masters), or playing MP3 files or videos, all DragonFlies make these experiences much more compelling and immersive.

DragonFly Black delivers great performance and value. Red ups the game with more power, more grip, and deeper sonic immersion. Now, DragonFly Cobalt, with its more advanced processor, microcontroller, and RF noise filtering, provides even greater clarity, dynamics, and finesse than previously possible.



## DragonFly DAC + Preamp + Headphone Amp

- Plays all music files: MP3 to High-Res and MQA
- Compatible with Apple® and Windows® PCs
- Compatible with iOS devices (requires Apple Lightning to USB 3 Camera Adaptor)
- Compatible with Android devices (requires DragonTail or other USB Adaptor for Android Devices)
- Bit-perfect variable output drives headphones, powered speakers, or power amp
- Fixed output feeds preamp or receiver



	DragonFly Black	DragonFly Red	DragonFly Cobalt
<b>Output</b>	1,2 volts	2,1 volts	
<b>DAC Chip</b>	ESS ES9010 with minimum-phase fast roll-off filter	ESS ES9016 with minimum-phase fast roll-off filter	ESS ES9038Q2M DAC chip with minimum-phase slow roll-off filter for more natural sound
<b>Volume Control</b>	Analog Volume Control	64-Bit Bit-Perfect Digital Volume Control	
<b>Desktop Compatibility</b>	Windows 7 and later; Apple 10.6.8 and later; Linux (no tech support provided)		
<b>Mobile Compatibility</b>	Apple iOS 5 and later; Android 5,0 and later		
<b>Included Adaptor</b>			DragonTail A to C Adaptor
<b>Accessories</b>	Protective Endcap, Leatherette Pouch		
<b>Dimensions</b>	62mm (l) x 19mm (w) x 12mm (h)	62mm (l) x 19mm (w) x 12mm (h)	57mm (l) x 19mm (w) x 12mm (h)
	<b>Euro Retail: 119,00</b>	<b>Euro Retail: 229,00</b>	<b>Euro Retail: 329,00</b>

## USB Extenders and Adaptors

DragonTail USB Extenders feature 5% Silver Solid Conductors and are Direction-Controlled for reduced RF noise.



### DragonTail USB A 2.0 Extender

Female USB A to Male A

**Euro Retail: 29,95**



### DragonTail USB A to Micro Adaptor

Female USB A to Male Micro

**Euro Retail: 29,95**



### DragonTail A to C Adaptor

(included with DragonFly Cobalt)

**Euro Retail: 29,95**

## JitterBug FMJ USB 2.0 Noise Filter (Data & Power)

- Enables more spacious and compelling sound
- Dual Discrete Noise-Dissipation Circuits reduce all forms of internal noise in both the sending and receiving electronics
- Full Metal Jacket (FMJ) with hinged Carbon-Loaded Noise-Dissipation input cover protects against external noise
- Reduces jitter and packet errors
- Use one JitterBug in series with almost any USB DAC, including DragonFlies Black and Red; experiment with DragonFly Cobalt
- For an additional improvement, use a second JitterBug in parallel—always desirable with DragonFly Cobalt

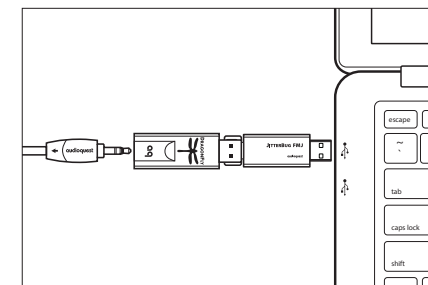

**Euro Retail: 69,00**

# AC Power Conditioners

## Niagara and PowerQuest: Low-Z Power | Noise-Dissipation Systems

*Redefining the science of AC power conditioning*

What is a power conditioner and why is it necessary?

For some, a power conditioner is merely a device that provides enough outlets for the entire audio/video system while also protecting the connected devices from electrical storms and wiring faults. Yet, for the discriminating listener, many power conditioners can make an audio/video system perform far worse.

Yes, a home or building may have dimming lights or an occasional brown-out, and the utilities' AC sine wave is always far from perfect. However, where incoming power is concerned, there are two reasons an audio/video system does not perform up to its full potential: 1) The current transients that supply the power amplifier are compressed, and 2) The ever-increasing levels of radio-frequency noise are masking (covering up) the system's low-level signal content.

When compared to or measured against either Niagara or PowerQuest, a simple power bar or a dedicated AC wall outlet can lose up to a third of the low-level audio information that contain much of a recording's harmonics, imaging, high frequencies, and bottom-end grip—and once that information is gone, it's gone forever.

AudioQuest's Niagara and PowerQuest technologies are unique amongst all power products—whether they're isolation transformers, AC regenerators, battery back-up, re-clocking devices, or other types. Niagara and PowerQuest filters and Ground-Noise Dissipation work evenly, or linearly, across a far wider range of induced noise frequencies. Additionally, Niagaras 3000, 5000, and 7000 feature Transient Power Correction, which supplies a current reservoir to greatly bolster the performance of any power amplifier.







	<b>PowerQuest 2</b>	<b>PowerQuest 3</b>	<b>Niagara 1200</b>	<b>Niagara 3000</b>	<b>Niagara 5000</b>	<b>Niagara 7000</b>
<b>Linear Noise-Dissipation Technology</b>	More than 18 octaves of differential filtering	More than 18 octaves of differential filtering; 14 octaves common-mode filtering	Level-X More than 19 octaves of differential filtering	Level-X More than 21 octaves differential-mode filtering	Level-X More than 23 octaves differential-mode filtering; 16 octaves common-mode filtering	Level-X More than 23 octaves differential-mode filtering; 20 octaves common-mode filtering
<b>Patented Ground-Noise Dissipation</b>	1 outlet	2 outlets	2 banks (all outlets)	3 banks (all outlets)	6 banks (all outlets)	6 banks (all outlets)
<b>Non-Sacrificial Surge Protection</b>	Withstands multiple AC surges and spikes up to 6000V/3000A without sustaining damage		Sonically Non-Invasive; Withstands multiple AC surges and spikes up to 6000V/3000A without sustaining damage			
<b>Transient Power Correction</b>	N/A	N/A	N/A	55 amps peak; Provides a current reservoir for any power amplifier (up to 25mS)	80 amps peak; Provides a current reservoir for any power amplifier (up to 25mS)	80 amps peak; Provides a current reservoir for any power amplifier (up to 25mS)
<b>Patented DBS Symmetrical Power Isolation Transformer</b>	N/A	N/A	N/A	N/A	N/A	2 (source component outlet banks)
<b>Maximum RMS Current</b>	10 Amps (RMS) @ 220-240v	10 Amps (RMS) @ 220-240v	10 Amps (RMS) @ 220-240v	10 Amps (RMS) @ 220-240v	16 Amps (RMS) @ 220-240v	16 Amps (RMS) @ 220-240v
<b>Outlets</b>	6 total: (1) 4K/8K Video, (3) Source, (2) High-Current	8 total: (2) 4K/8K Video, (4) Source, (2) High-Current	7 total: (5) Source (including video), (2) High-Current	7 total: (5) Source (including video), (2) High-Current	12 total: (8) Source (including video), (4) High-Current	12 total: (8) Source, (4) High-Current
<b>USB-A Charging Ports</b>	2 high-speed ports (3.4 amp capacity)	4 high-speed ports (4.8 amp capacity)	N/A	N/A	N/A	N/A
<b>Power Cable</b>	Direction-Controlled Semi-Solid Concentric - 2,1m long		Power cable not included - For optimal results use a cable that features ZERO and GND Technology			
<b>Signal Line Protection</b>	N/A	Network	N/A	N/A	N/A	N/A
<b>Dimensions</b>	393mm L x 80mm W x 153mm H (Includes wall-mounting holes and detachable base)	393mm L x 80mm W x 188mm H (Includes wall-mounting holes and detachable base)	493mm W x 81mm H x 190mm D	445mm W x 88mm H x 386mm D (2-RU rack mount kit included)	445mm W x 133mm H x 437mm D (3-RU rack mount kit on request)	445mm W x 133mm H x 437mm D (3-RU rack mount kit on request)
<b>Weight</b>	2,2 kg	2,5 kg	8,2 kg	11,3 kg	17,2 kg	39 kg
	<b>Euro Retail: 269,00</b>	<b>Euro Retail: 399,00</b>	<b>Euro Retail: 1.299,00</b>	<b>Euro Retail: 3.995,00</b>	<b>Euro Retail: 5.995,00</b>	<b>Euro Retail: 10.995,00</b>

# AC Power Cables

## Low-Z | Noise-Dissipation NRG, Wind, and Storm Series

The power cables that are supplied with most audio/video components have many admirable features. They're durable, flexible, small, and they will unfailingly supply the required AC voltage from the utilities' service tap for many years to come. They're also inexpensive.

Unfortunately, these "commodity" power cables were never up to the task of supplying sensitive components with the quality power they need. By this, we mean power that is unrestricted when delivering current transients to a power amplifier. The power cable must not add noise to the audio/video signal via RF (radio-frequency) noise that is induced into, or picked up by, the AV component. The ground lead is the worst offender in this regard, as it has no component power supply to help lessen the damage from the induced RF noise. Typically, the ground noise drains directly towards the component's signal path.

Even with an advanced AC power system like Niagara or PowerQuest, the AC power cable is a branch of noise-dissipation system. Like plumbing, the RF noise must be drained away from the circuits upon which it could do harm. Many ask, if my wall wiring is so many yards in length, how can a 6-foot cable possibly matter? It matters for the same reason four square inches of mud and debris can back up a plumbing system or a rain gutter. The drainage or distribution of water currents and noise currents work in the exact same manner. They are one system.

With AudioQuest AC power cables and our unique technologies such as ZERO-Tech (No Characteristic Impedance) and our patented RF/ND-Tech, you will experience greater dynamics, bass grip, extended high frequencies, and the blackest background you've ever heard.

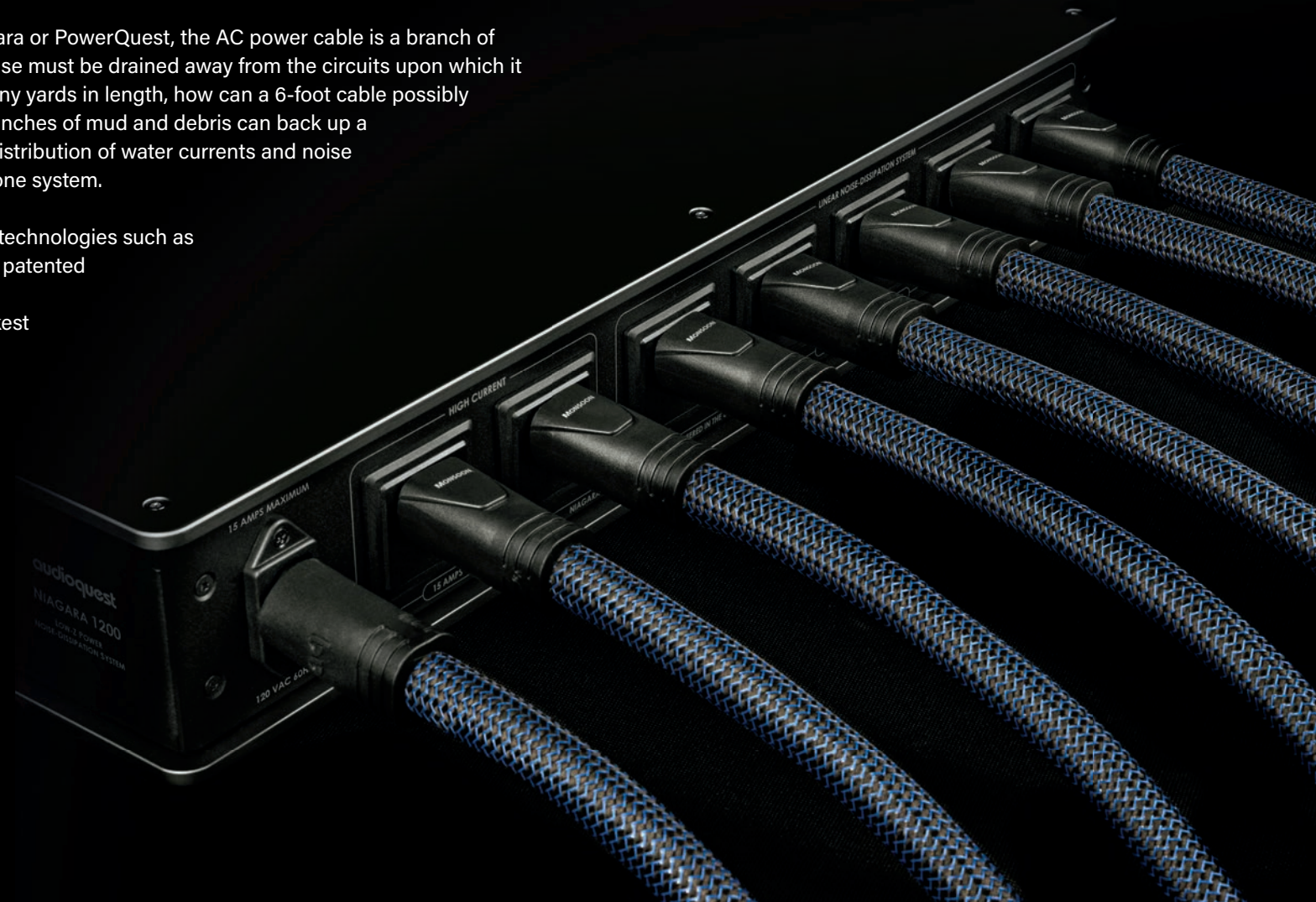

# AC Power Cables: NRG Series

NRG AC cables available in Installer 5-Packs, page 58.

**C5**  
2,5A Maximum RMS Capacity @ 230VAC 50Hz



**C7**  
2,5A Maximum RMS Capacity @ 230VAC 50Hz



**C13**  
15A Maximum RMS Capacity @ 230VAC 50Hz



NRG-Y2 and NRG-Z2 cables use a 2-pole C7 connector—and yet feature a 3-prong wall plug. The additional ground connection is necessary to enable ZERO-Tech, and to maximize RF-Noise Dissipation.



Model	NRG-X2	NRG-Y2	NRG-Z2	NRG-X3	NRG-Y3	NRG-Z3
<b>Metal</b>	Semi-Solid Concentric LGC		Semi-Solid Concentric PSC+	Semi-Solid Concentric LGC		Semi-Solid Concentric PSC+
<b>Gauge</b>	1,04mm <sup>2</sup> (2,5 Amp @ 220-240V)			1,31mm <sup>2</sup> (C13 Plug: 10 Amp @ 220-240v, C5 Plug: 2,5 amps @ 220-240v)	2,08mm <sup>2</sup> (C13 Plug: 10 Amp @ 220-240v)	2,08mm <sup>2</sup> (10 Amp @ 220-240v)
<b>Technology</b>	-	ZERO Tech (No Characteristic Impedance)		-	ZERO Tech (No Characteristic Impedance)	ZERO Tech (No Characteristic Impedance); Patented RF/ND-Tech
<b>Jacket</b>	Black PVC with Red Stripes	Dark Gray/Black Braid	Dark Red/Black Braid	Black PVC with Red Stripes	Dark Gray/Black Braid	Dark Red/Black Braid
<b>Terminations</b>	Gold-Welded Connectors					
<b>Length</b>	<b>Euro Retail</b>	<b>Euro Retail</b>	<b>Euro Retail</b>	<b>Euro Retail</b>	<b>Euro Retail</b>	<b>Euro Retail</b>
<b>1m</b>	74,95	134,95	209,00	89,95	159,95	259,00
<b>2m</b>	89,95	159,95	269,00	109,95	199,95	359,00
<b>3m</b>	104,95	184,95	329,00	129,95	239,95	459,00
<b>4,5m</b>	129,45	-	-	159,95	-	-
<b>6m</b>	149,95	-	-	189,95	-	-



**C17**  
For components that use the ungrounded C17 connector, please use AQ cables with a C13 connector. The grounded male plug is necessary to make use of our Noise-Dissipation System.

Note: NRG-X3 with C5 connector is available in 1m, 2m & 3m only

# AC Power Cables: Wind Series

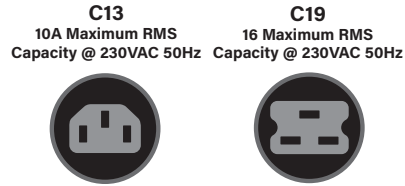

Never assume which of these is required for a component or power conditioner. Some manufacturers prefer the performance of one IEC inlet type over another—even when their circuit's current draw is minimal.



Wind Series Plugs

Wind XTRM Plugs Built From Storm-Level Components

XTRM cables have upgraded plugs equivalent in quality to the Storm Series plugs.

Model	Monsoon	Monsoon XTRM	Blizzard ● 72v DBS	Blizzard XTRM ● 72v DBS	Silver Cloud ● 72v DBS	Silver Cloud XTRM ● 72v DBS
Plug Type	Direct-Gold Plated Molded	Hanging-Silver over Red and Beryllium Coppers	Direct-Gold Plated Molded	Hanging-Silver over Red and Beryllium Coppers	Direct-Gold Plated Molded	Hanging-Silver over Red and Beryllium Coppers
Metal	Semi-Solid True-Concentric Perfect-Surface Copper+ (PSC+) and Long-Grain Copper (LGC)		Semi-Solid True-Concentric Perfect-Surface Copper+ (PSC+)		Semi-Solid True-Concentric Perfect-Surface Silver (PSS) and Perfect-Surface Copper+ (PSC+)	
Gauge	3,31mm <sup>2</sup>					
Technology	ZERO-Tech (No Characteristic Impedance) for Uncompressed Current Transfer; RF/ND-Tech					
Jacket	Dark Blue/Black Braid 		Silver/Black Braid 		Black/Black Braid 	
Terminations	Direct-Gold and Silver Plated; Cold-Welded Connectors					
Length	<b>Euro Retail</b>	<b>Euro Retail</b>	<b>Euro Retail</b>	<b>Euro Retail</b>	<b>Euro Retail</b>	<b>Euro Retail</b>
1m	459,00	809,00	769,00	1.119,00	2.149,00	2.499,00
2m	619,00	969,00	989,00	1.339,00	3.749,00	4.099,00
3m	779,00	1.129,00	1.209,00	1.559,00	5.349,00	5.699,00
Other prepared lengths use formula:	-	160,00/m + 649,00	-	220,00/m + 899,00	-	1.600,00/m + 899,00

## Mistral AC Power Bulk Cable

**Metal:** Semi-Solid True-Concentric Perfect-Surface Copper+ (PSC+) and Long-Grain Copper (LGC)

**Gauge:** 3,31mm<sup>2</sup>

**Technology:** RF/ND-Tech

**Jacket:** Dark Gray/Light Gray PVC

**Terminations:** Mistral AC Power Plugs

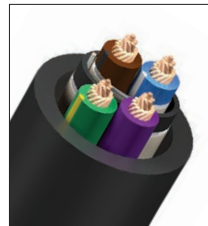

**50m Spool**

**Retail: 130,00/m**

## Mistral AC Power Plugs

Sold separately.



**Mistral Wall Plug**  
Retail: 149,00



**Mistral IEC C-13 Plug**  
Retail: 149,00



**Mistral IEC C-19 Plug**  
Retail: 149,00

# AC Power Cables: Storm Series

Never assume which of these is required for a component or power conditioner. Some manufacturers prefer the performance of one IEC inlet type over another—even when their circuit's current draw is minimal.

**C13 or C15**  
10 Amp Maximum RMS  
Capacity @ 230VAC 50Hz











**C19**  
16 Maximum RMS  
Capacity @ 230VAC 50Hz





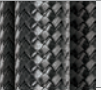

Plugs for Storm Series

**High (Variable) Current AC Power Cables** - Optimized for use with AC power conditioners/regenerators, power amplifiers, and any components that contain a built-in power amplifier, including AV receivers, powered speakers, and powered subwoofers.

Model	 <b>Thunder</b> ● 72v DBS	 <b>Tornado</b> ● 72v DBS	 <b>Hurricane</b> ● 72v DBS	 <b>FireBird</b> ● 72v DBS	 <b>Dragon</b> ● 72v DBS
<b>Conductor Metal</b>	Solid Perfect-Surface Copper+ (PSC+) plus Long-Grain Copper (LGC)		Solid Perfect-Surface Copper+ (PSC+)		Solid Perfect-Surface Silver (PSS) plus Solid Perfect-Surface Copper+ (PSC+)
<b>RF Drain Metal</b>	Solid 6% Silver			Solid Perfect-Surface Silver (PSS)	
<b>Technology</b>	ZERO-Tech (No Characteristic Impedance) for Uncompressed Current Transfer; RF/ND-Tech				
<b>Jacket</b>	Brown/Black Braid 	Silver/Black Braid 	Dark Blue/Black Braid 	Dark Red/Black Braid 	Black/Black Braid 
<b>Termination and Gauge</b>	Hanging-Silver over Red and Beryllium Copper - 4,17mm <sup>2</sup> Line and Neutral - 3,31mm <sup>2</sup> Ground				
<b>Length</b>	<b>Euro Retail</b>	<b>Euro Retail</b>	<b>Euro Retail</b>	<b>Euro Retail</b>	<b>Euro Retail</b>
1m	1.099,00	1.499,00	1.999,00	3.699,00	5.899,00
2m	1.349,00	1.899,00	2.899,00	6.299,00	10.699,00
3m	1.599,00	2.299,00	3.799,00	8.999,00	15.499,00
<b>Other prepared lengths use formula:</b>	250,00/m + 849,00	400,00/m + 1.099,00	900,00/m + 1.099,00	2.600,00/m + 1.099,00	4.800,00/m + 1.099,00

**Constant-Current (Source) AC Power Cables** - Optimized for use with audio/video source components, which have a constant or "fixed" current draw.

Model	-	 <b>Tornado</b> ● 72v DBS	 <b>Hurricane</b> ● 72v DBS	 <b>FireBird</b> ● 72v DBS	 <b>Dragon</b> ● 72v DBS
<b>Conductor Metal</b>	-	Solid Perfect-Surface Copper+ (PSC+)		Solid Perfect-Surface Silver (PSS)	
<b>RF Drain Metal</b>	-	Solid 6% Silver		Solid Perfect-Surface Silver (PSS)	
<b>Termination and Gauge</b>	-	Hanging-Silver over Red and Beryllium Copper - 1,31mm <sup>2</sup> Line, Neutral and Ground			
<b>Length</b>	-	<b>Euro Retail</b>	<b>Euro Retail</b>	<b>Euro Retail</b>	<b>Euro Retail</b>
1m	-	1.199,00	1.539,00	3.099,00	4.699,00
2m	-	1.399,00	2.079,00	5.199,00	8.399,00
3m	-	1.599,00	2.619,00	7.299,00	12.099,00
<b>Other prepared lengths use formula:</b>	-	200,00/m + 999,00	540,00/m + 999,00	2.100,00/m + 999,00	3.700,00/m + 999,00

## AC Power Accessories



### IEC90°/1

Adaptor Bends in Direction of 1 Center

**Retail: 22,95**



### IEC90°/2

Adaptor Bends in Direction of 2 Outer Pins

**Retail: 22,95**

### Female to Male IEC C-13 Adaptors

Premium Single-Piece Metal Conductors from Input to All Outputs Preserve Advantages of Superior AudioQuest NRG Series AC Cables.



### C7 90° Adaptor Kit

- Provides 90° bends for C7 power connections
- Also connects for double bends
- Non-polarized for maximum flexibility

Package contains:

- 1 x "E" adaptor
- 1 x "U" adaptor

**Retail: 45,90**

**C7 90° Adaptors also available in Installer 5-Packs, page 58.**

### Fog Lifters

Reduce the RF noise that capacitively couples into cables through all solid materials (carpet, stone, wood, etc.)



**Set of 8**

**Retail: 159,00**

# Speaker Cables

## Meticulously Designed to Minimize Noise and Distortion

### Do No Harm: The Four Elements Today

AudioQuest's Four Elements are always applied in the most thoughtful, effective ways to offer the best performance for the money—at all price points. While our implementation of these techniques has evolved over the years, our guiding principle remains the same: *Do No Harm*.

### Solid Conductors

Strand interaction remains the biggest potential source of distortion in cables. Solid Conductors are the aspirational ideal and most complete solution to this problem. However, thoughtfully arranged multi-conductor geometries such as concentric windings are used to create our Semi-Solid Conductor technologies. These avoid many strand-distortion mechanisms and are in their own right ideal in a growing number of applications.

### High-Purity Metal

Higher-purity conductor metals with smoother surfaces and internal crystal structures greatly reduce noise and distortion. Carefully finessed mixes of metals and conductor sizes can be effectively used to define a cable's *Sonic Signature*—a cost-effective technique for high-value, high-performance models.

### Noise-Dissipation

Unwanted Radio-Frequency (RF) noise is and has always been picked up and induced into cable. This contamination ultimately masks and distorts critical portions of the audio/video signal. As this distortion-causing (parasitic) RF signal is more present today than at any previous time in history, we must depend on a wider arsenal of Noise-Dissipation technologies:

- Directionally Controlled conductors minimize high-frequency noise by “directing” or draining it away from the most vulnerable circuits.
- ZERO-Technology (No Characteristic Impedance) applies Ultra-Linear Noise-Dissipation across the widest range of frequencies possible. It also enables uncompressed transient current transfer for AC power and loudspeaker/power amplifier applications.
- RF/ND-Tech (Patented Radio-Frequency Ground-Noise Dissipation) minimizes circuit misbehavior by cancelling induced RF noise.
- Tried-and-true DBS has evolved to include RF-Noise Traps that further reduce dielectric distortion and induced noise.

### Dielectric

Insulation is necessary between conductors to minimize signal interaction and electrical shorts. The ideal is virtually no dielectric interaction (such as is achieved with our ZERO-Technology). However, by optimizing the dielectric material between signal conductors, this distortion is greatly minimized.



# Speaker Cable Applications

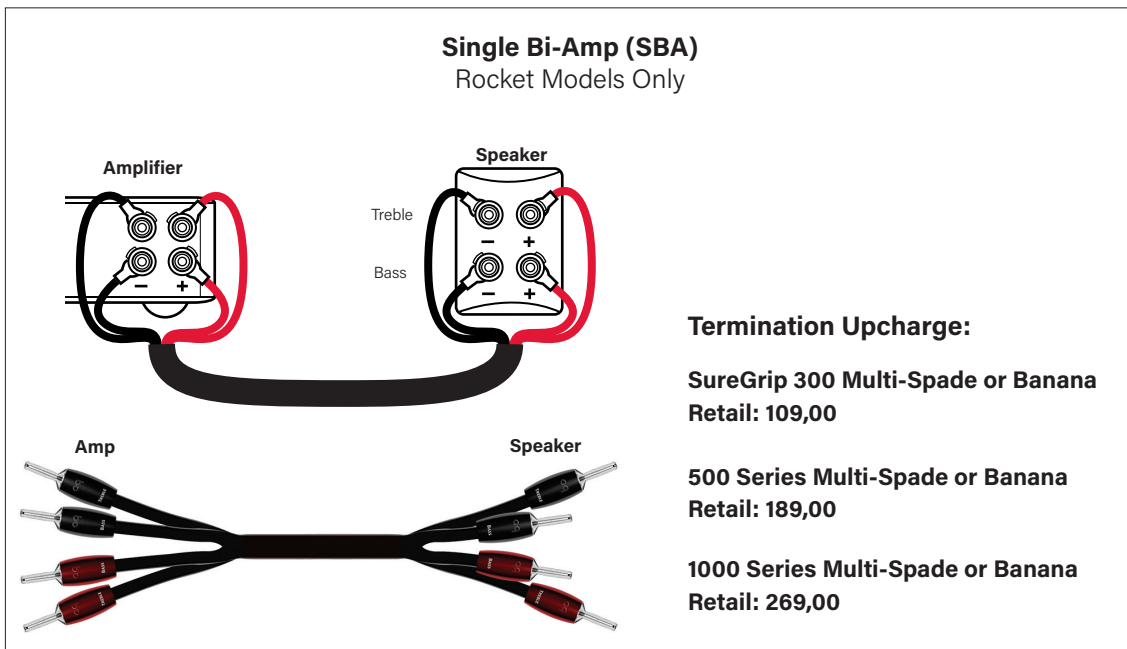
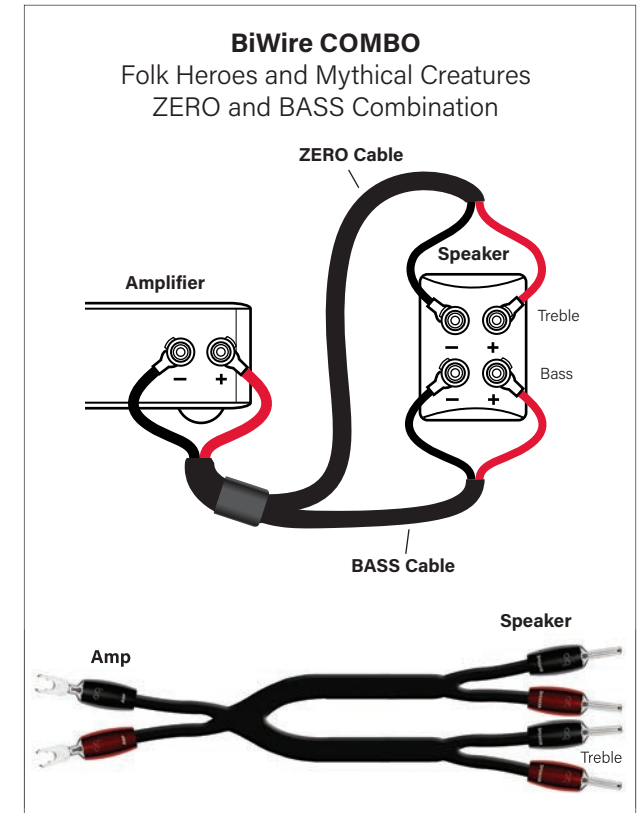
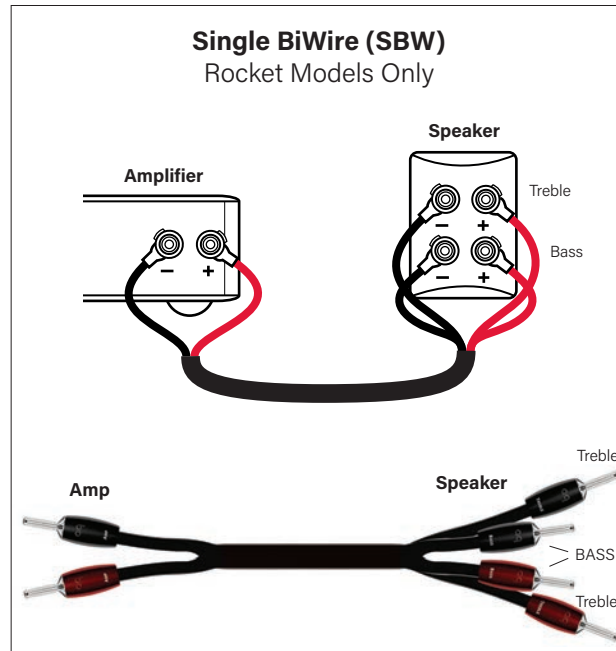
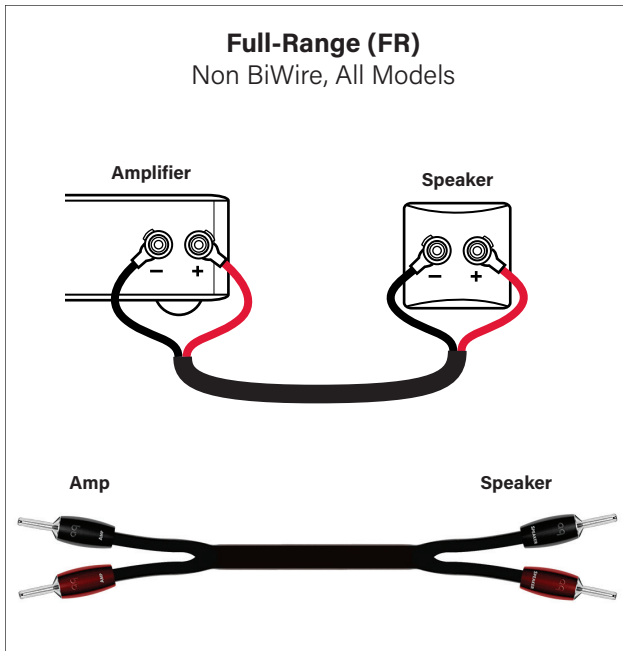

**Termination Upcharge:**

**SureGrip 300 Multi-Spade or Banana**  
Retail: 109,00

**500 Series Multi-Spade or Banana**  
Retail: 189,00

**1000 Series Multi-Spade or Banana**  
Retail: 269,00





## Mythical Creature & Folk Hero Termination Options: Bananas or Spades?

### Amplifier-End Connector:

Choice of 1000 Series Multi-Spade, Banana, U-Spade, or V-Spade (Silver only)



Insulated (compliant) binding posts may not allow for 2 sets of connectors.

Often, the choice between terminating speaker cables with spade lugs or banana plugs will come down to personal preference. However, today's EU-compliant isolated binding posts are being used on more power amplifiers than ever before. This sometimes makes it difficult, if not impossible, to use a banana connector. Further, given the girth and weight of our Mythical Creature Series speaker cables, a spade may be better capable of fully supporting the cable. This is particularly a concern with binding posts that do not allow a banana connector to fully seat into the post.

Further, the EU-compliant posts will neither accept our V-Spade nor allow our Multi-Spade to be fully seated. For these applications (or when you're not certain), **we highly recommend the U-Spade**, as it can accommodate any binding post. The V-Spade is a specialty spade connector that works well with large wingnut binding posts (such as the Mundorf), as it allows extra clearance.

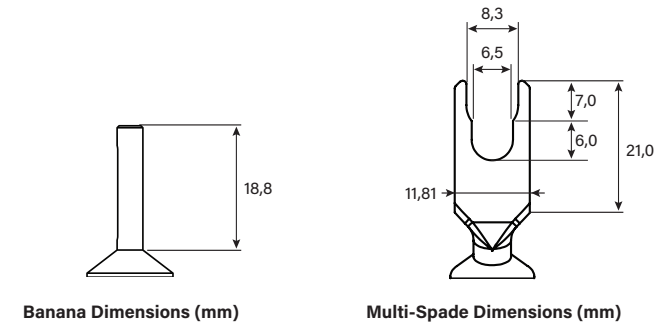

Banana Dimensions (mm)

Multi-Spade Dimensions (mm)

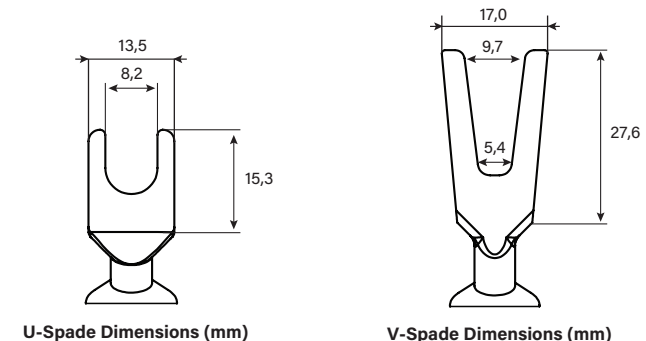

U-Spade Dimensions (mm)

V-Spade Dimensions (mm)

### Speaker-End Connector:

Choice of 1000-Series Spade or Banana (Silver only)

Here we typically recommend the U-Spade or banana connector. However, even though there is less weight and pressure on this side of the cable (particularly for BiWire sets), it is nevertheless important to note the binding post's design. If a banana connector cannot seat all the way into the binding post, we recommend one of our spade connectors.

## How to Order Prepared Speaker Cables

First please specify type of connector (banana or appropriate spade), then the finish of connector (silver\*).

(\*or gold where applicable)

Pair prices shown. Also available in singles (i.e. for center channel, subwoofer, or mono) at half pair price.

When ordering any factory-terminated speaker cable, please include the required elements shown in the examples below:

Qty.	Pair or Single	Length	Model	FR/BWC/SBW	Amplifier Termination	Speaker Termination	Silver or Gold
1	Pair	3m	Rocket 88	FR	Spade	Banana	Silver
1	Single	2m	William Tell	COMBO	U-Spade	Banana	N/A
1	Single	3m	Rocket 44	SBW	Spade	Banana	Gold

## Speaker Cables: Q2 and Type Series (5, 9, Type 9+DBS)

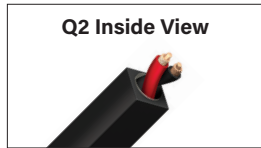

Model	Q2	Type 5	Type 9	Type 9+DBS ● 72v DBS
<b>Metal</b>	Concentric Long-Grain Copper (LGC)	Solid PSC+ Sonic-Signature Conductors and Long-Grain Copper (LGC)	Solid Perfect-Surface Copper+ (PSC+)	
<b>Gauge</b>	1,65mm <sup>2</sup>	1,65mm <sup>2</sup>	1,65mm <sup>2</sup>	1,65mm <sup>2</sup>
<b>Geometry</b>	Low-Inductance Twisted-Pair		Star-Quad	
<b>Noise-Dissipation</b>	No	Carbon-Based Noise-Dissipation	Multi-Layer Carbon-Based Noise-Dissipation	
<b>Jacket</b>	<b>Prepared:</b> Black PVC <b>Bulk:</b> White or Black PVC	<b>Prepared:</b> Brown/Black Braid <b>Bulk:</b> Red Striped PVC	Red/Black Braid	
<b>Plugs</b>	<b>Prepared:</b> SureGrip 100 (Silver) Banana <b>Bulk:</b> SureGrip 100 (Silver or Gold) Banana	SureGrip 300 (Silver or Gold) Choice of Multi-Spade or Banana	500 Series (Silver or Gold) Choice of Multi-Spade or Banana	1000 Series (Silver) Choice of Multi-Spade or Banana
<b>Prepared Lengths</b>	<b>Euro Retail</b>	<b>Euro Retail</b>	<b>Euro Retail</b>	<b>Euro Retail</b>
2m Pair	-	569,00	789,00	1.239,00
2,5m Pair	-	599,00	849,00	1.299,00
3m Pair	329,00	629,00	909,00	1.359,00
4m Pair	-	689,00	1.029,00	1.479,00
Other prepared lengths use formula (per pair)	-	60,00/m + 449,00	120,00/m + 549,00	120,00/m + 999,00
<b>Bulk Cables (on spools)</b>	<b>Euro Retail</b>	<b>Euro Retail</b>	<b>Euro Retail</b>	<b>Euro Retail</b>
50m	-	-	-	-
100m	16,50/m	30,00/m	-	-

# Speaker Cables: Rocket Series

Please Specify Termination

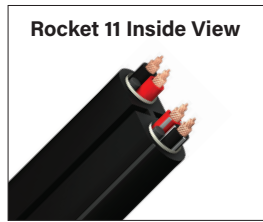

Model	Rocket 11	Rocket 22	Rocket 33	Rocket 44	Rocket 88 72v DBS
Application Options	Full-Range and Single-BiWire	Full-Range, Single-BiWire, REL and Optimized for Naim			
Metal	Semi-Solid Concentric Long-Grain Copper (LGC)	Semi-Solid Concentric PSC and LGC	Solid PSC and LGC	Solid PSC+ and PSC	Solid PSC+
Gauge	2,08mm <sup>2</sup>	3,31mm <sup>2</sup>	2,08mm <sup>2</sup>	3,31mm <sup>2</sup>	
Geometry	Double Spiral-Pair		Double Star-Quad		
Dielectric	PVC		Foamed-Polyethylene (For All Positive Conductors)		
Noise-Dissipation	No	Carbon-Based Noise-Dissipation			
Jacket	Black PVC with Gray Stripes	Black PVC with Blue Stripes	Red/Black Braid or PVC	Silver/Black Braid or PVC	Green/Black Braid or PVC
Plugs	SureGrip 300 (Silver or Gold) Choice of Multi-Spade or Banana		SureGrip 300 (Silver or Gold) Choice of Multi-Spade or Banana	500 Series (Silver or Gold) Choice of Multi-Spade or Banana	
Prepared Lengths	<b>Euro Retail</b>	<b>Euro Retail</b>	<b>Euro Retail</b>	<b>Euro Retail</b>	<b>Euro Retail</b>
2m Pair	379,00	499,00	629,00	799,00	1.219,00
2,5m Pair	399,00	549,00	699,00	899,00	1.349,00
3m Pair	419,00	599,00	769,00	999,00	1.479,00
4m Pair	459,00	699,00	909,00	1.199,00	1.739,00
Other prepared lengths use formula (per pair)	40,00/m + 299,00	100,00/m + 299,00	140,00/m + 349,00	200,00/m + 399,00	260,00/m + 699,00
Bulk Cables (on spools)	<b>Euro Retail</b>	<b>Euro Retail</b>	<b>Euro Retail</b>	<b>Euro Retail</b>	<b>Euro Retail</b>
50m	20,00/m	50,00/m	70,00/m	100,00/m	130,00/m
100m	20,00/m	20,00/m	70,00/m	-	-

# Speaker Cables: Robin Hood (Folk Heroes)



Model	Robin Hood ZERO ● 72v DBS	Robin Hood BASS ● 72v DBS	Robin Hood ZERO BiWire COMBO (ZERO + BASS) ● 72v DBS	Robin Hood SILVER ● 72v DBS	Robin Hood SILVER BiWire COMBO (SILVER + BASS) ● 72v DBS
<b>Metal</b>	Solid Perfect-Surface Copper+ (PSC+)		Refer to Specs for ZERO and BASS	Solid PSS Sonic-Signature Conductors and PSC+	Refer to Specs for SILVER and BASS
<b>Gauge</b>	1,65mm <sup>2</sup>			1,65mm <sup>2</sup>	
<b>Geometry</b>	ZERO-Tech (No Characteristic Impedance)			ZERO-Tech (No Characteristic Impedance)	
<b>Noise-Dissipation</b>	Multi-Layer Carbon-Based Noise-Dissipation	RF/ND-Tech		Multi-Layer Carbon-Based Noise-Dissipation	
<b>Jacket</b>	Dark Green/Black Braid	Black Braid		Light Gray/Black Braid	
<b>Application Options</b>	Full-Range, or BiWire COMBO (when combined with BASS cable)	BiWire COMBO (when combined with ZERO cable)	Full-Range, or combined with BASS to form a BiWire COMBO		
<b>Plug Options</b> (1000 Series, Silver)	AMP-Side: Choice of U-Spade (recommended default), Banana, Multi-Spade, or V-Spade / SPEAKER-Side: Choice of U-Spade (recommended default), Banana, or Multi-Spade				
<b>Prepared Lengths</b>	<b>Euro Retail</b>	<b>Euro Retail</b>	<b>Euro Retail</b>	<b>Euro Retail</b>	<b>Euro Retail</b>
2m Pair	1.899,00	1.899,00	3.799,00	6.399,00	8.299,00
2,5m Pair	2.099,00	2.099,00	4.199,00	7.699,00	9.799,00
3m Pair	2.299,00	2.299,00	4.599,00	8.999,00	11.299,00
4m Pair	2.699,00	2.699,00	5.399,00	11.599,00	14.299,00
<b>Other prepared lengths use formula (per pair)</b>	<b>400,00/m + 1.099,00</b>	<b>400,00/m + 1.099,00</b>	<b>800,00/m + 2.199,00</b>	<b>2.600,00/m + 1.199,00</b>	<b>3.000,00/m + 2.299,00</b>

# Speaker Cables: William Tell (Folk Heroes)



Model	William Tell ZERO ● 72v DBS	William Tell BASS ● 72v DBS	William Tell ZERO BiWire COMBO (ZERO + BASS) ● 72v DBS	William Tell SILVER ● 72v DBS	William Tell SILVER BiWire COMBO (SILVER + BASS) ● 72v DBS
<b>Metal</b>	Solid Perfect-Surface Copper+ (PSC+)	Solid PSC+ Sonic-Signature Conductors and LGC	Refer to Specs for ZERO and BASS	Solid PSS Sonic-Signature Conductors and PSC+	Refer to Specs for SILVER and BASS
<b>Gauge</b>	2,62mm <sup>2</sup>			2,62mm <sup>2</sup>	
<b>Geometry</b>	ZERO-Tech (No Characteristic Impedance)			ZERO-Tech (No Characteristic Impedance)	
<b>Noise-Dissipation</b>	Multi-Layer Carbon-Based Noise-Dissipation	RF/ND-Tech		Multi-Layer Carbon-Based Noise-Dissipation	
<b>Jacket</b>	Dark Red/Black Braid	Black Braid		Silver/Black Braid	
<b>Application Options</b>	Full-Range, or BiWire COMBO (when combined with BASS cable)	BiWire COMBO (when combined with ZERO cable)		Full-Range, or BiWire COMBO (when combined with BASS cable)	
<b>Plug Options</b> (1000 Series, Silver)	<b>AMP-Side:</b> Choice of U-Spade (recommended default), Banana, Multi-Spade, or V-Spade / <b>SPEAKER-Side:</b> Choice of U-Spade (recommended default), Banana, or Multi-Spade				
<b>Prepared Lengths</b>	<b>Euro Retail</b>	<b>Euro Retail</b>	<b>Euro Retail</b>	<b>Euro Retail</b>	<b>Euro Retail</b>
2m Pair	3.099,00	2.699,00	5.799,00	8.199,00	10.899,00
2,5m Pair	3.499,00	2.999,00	6.499,00	9.849,00	12.849,00
3m Pair	3.899,00	3.299,00	7.199,00	11.499,00	14.799,00
4m Pair	4.699,00	3.899,00	8.599,00	14.799,00	18.699,00
<b>Other prepared lengths use formula (per pair)</b>	<b>800,00/m + 1.499,00</b>	<b>600,00/m + 1.499,00</b>	<b>1.400,00/m + 2.999,00</b>	<b>3.300,00/m + 1.599,00</b>	<b>3.900,00/m + 3.099,00</b>

## Speaker Cables: ThunderBird (Mythical Creatures)



Model	ThunderBird ZERO ● 72v DBS	ThunderBird BASS ● 72v DBS	ThunderBird ZERO BiWire COMBO (ZERO + BASS) ● 72v DBS
Metal	Solid Perfect-Surface Copper+ (PSC+)	Solid PSC+ Sonic-Signature Conductors and LGC	Refer to Specs for ZERO and BASS
Gauge	5,26mm <sup>2</sup>		
Geometry	ZERO-Tech (No Characteristic Impedance)		
Noise-Dissipation	Multi-Layer Carbon-Based Noise-Dissipation	RF/ND-Tech	
Jacket	Blue/Black Braid		
Application Options	Full-Range, or BiWire COMBO (when combined with BASS cable)	BiWire COMBO (when combined with ZERO cable)	
Plug Options (1000 Series, Silver)	AMP-Side: Choice of U-Spade (recommended default), Banana, Multi-Spade, or V-Spade / SPEAKER-Side: Choice of U-Spade (recommended default), Banana, or Multi-Spade		
<b>Prepared Lengths</b>	<b>Euro Retail</b>	<b>Euro Retail</b>	<b>Euro Retail</b>
2m Pair	5.300,00	4.300,00	9.600,00
2,5m Pair	6.050,00	4.800,00	10.850,00
3m Pair	6.800,00	5.300,00	12.100,00
4m Pair	8.300,00	6.300,00	14.600,00
Other prepared lengths use formula (per pair)	1.500,00/m + 2.300,00	1.000,00/m + 2.300,00	2.500,00/m + 4.600,00

## Speaker Cables: FireBird (Mythical Creatures)



Model	FireBird ZERO ● 72v DBS	FireBird BASS ● 72v DBS	FireBird BiWire COMBO (ZERO + BASS) ● 72v DBS
Metal	Solid Perfect-Surface Silver (PSS) Sonic-Signature Conductors and Perfect-Surface Copper+ (PSC+)		Refer to Specs for ZERO and BASS
Gauge	10 AWG		
Geometry	ZERO-Tech (No Characteristic Impedance)		
Noise-Dissipation	Multi-Layer Carbon-Based Noise-Dissipation	RF/ND-Tech	
Jacket	Dark Red/Black Braid		
Application Options	Full-Range, or BiWire COMBO (when combined with BASS cable)	BiWire COMBO (when combined with ZERO cable)	
Plug Options (1000 Series, Silver)	AMP-Side: Choice of U-Spade (recommended default), Banana, Multi-Spade, or V-Spade / SPEAKER-Side: Choice of U-Spade (recommended default), Banana, or Multi-Spade		
Prepared Lengths	Euro Retail	Euro Retail	Euro Retail
2m Pair	15.500,00	11.500,00	27.000,00
2,5m Pair	18.800,00	13.800,00	32.600,00
3m Pair	22.100,00	16.100,00	38.200,00
4m Pair	28.700,00	20.700,00	49.400,00
Other prepared lengths use formula (per pair)	6.600,00/m + 2.300,00	4.600,00/m + 2.300,00	11.200,00/m + 4.600,00

# Speaker Cables: Dragon (Mythical Creatures)



Model	Dragon ZERO ● 72v DBS	Dragon BASS ● 72v DBS	Dragon BiWire COMBO (ZERO + BASS) ● 72v DBS
<b>Metal</b>	Solid Perfect-Surface Silver (PSS) Sonic-Signature Conductors and Perfect-Surface Copper+ (PSC+)		
<b>Gauge</b>	10 AWG		
<b>Geometry</b>	ZERO-Tech (No Characteristic Impedance)		
<b>Noise-Dissipation</b>	Multi-Layer Carbon-Based Noise-Dissipation	RF/ND-Tech	Refer to Specs for ZERO and BASS
<b>Jacket</b>	Black Braid		
<b>Application Options</b>	Full-Range, or BiWire COMBO (when combined with BASS cable)	BiWire COMBO (when combined with ZERO cable)	
<b>Plug Options</b> (1000 Series, Silver)	AMP-Side: Choice of U-Spade (recommended default), Banana, Multi-Spade, or V-Spade / SPEAKER-Side: Choice of U-Spade (recommended default), Banana, or Multi-Spade		
<b>Prepared Lengths</b>	<b>Euro Retail</b>	<b>Euro Retail</b>	<b>Euro Retail</b>
2m Pair	28.700,00	22.100,00	50.800,00
2,5m Pair	35.300,00	27.050,00	62.350,00
3m Pair	41.900,00	32.000,00	73.900,00
4m Pair	55.100,00	41.900,00	97.000,00
<b>Other prepared lengths use formula (per pair)</b>	<b>13.200,00/m + 2.300,00</b>	<b>9.900,00/m + 2.300,00</b>	<b>23.100,00/m + 4.600,00</b>



# Speaker Cable Accessories

## Bare Naked BiWire Jumpers

Solid PSC+ conductors offer dramatically superior performance to stamped jumpers.



Set of 4 (8.9 cm each)  
Retail: 49,95

## ThunderBird and Dragon BiWire Jumpers

Direction-Controlled Solid Perfect-Surface Copper+ (PSC+) Perfect-Surface Silver (PSS) and Carbon-Loaded Insulation. Available in Spade-Spade, Spade-Banana, Banana-Spade, and Banana-Banana.



**ThunderBird (PSC+)** uses Hanging-Silver 500 Series Bananas or Spades.

Set of 4 (20 cm each)  
Retail: 349,00



**Dragon (PSS)** uses Hanging-Silver 1000 Series Bananas or Spades.

Set of 4 (20cm each)  
Retail: 749,00

## Fog Lifters

Reduce the RF noise that capacitively couples into cables through all solid materials (carpet, stone, wood, etc.)



Set of 8  
Retail: 159,00

## Binding-Post Wrench

Real tool-quality double-ended nut driver with metal inserts. Fits 11,1 mm and 12,7 mm binding posts.



Retail: 19,95

## Using BiWire Jumpers with Full-Range Cables on BiWire Capable Speakers

### 3-Way or Panel-Hybrid Speaker

Please connect amp. directly to the critical midrange and tweeter Treble input, and then jumper down to the Bass input.

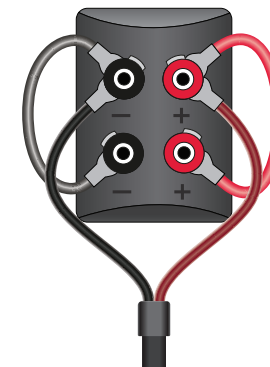

### 2-Way Speaker

To maintain the speaker design's delicate midrange/tweeter relationship, please connect signal to Treble (+) and Bass (-).

Treble  
Bass

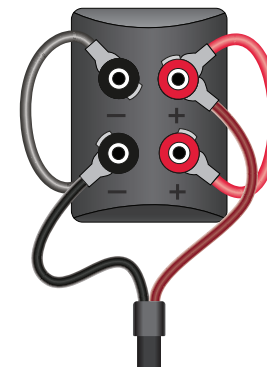

# Audio Interconnect Cables

## *The Higher You Climb, The Less You Hear?*

The evolution of AudioQuest's audio cables is a steady climb up a mountain whose summit we'll never reach — there is always room for improvement and growth, as evidenced by our new Mythical Horses and Mythical Creatures interconnects. Perhaps less intuitive is the fact that climbing up our Analog Interconnect line means you hear less of the cable.

The reason is simple: As more of the delicate audio signal is protected from damage along the way, the listener experiences more of the truth and emotional impact of the music. Greater faithfulness to the audio signal is made possible by the use of superior materials and the careful implementation of increasingly sophisticated design and construction techniques.

Music is wonderfully complex, and our ears are very sensitive to its nuances. The remarkably affordable Bridges & Falls Series is an amazing place to start the journey. For those who want better performance and can sacrifice the physical flexibility and diverse connectivity options afforded by Bridges & Falls, the Rivers and Elements are excellent choices. Every step up the ladder to the state-of-the-art Mythical Creatures Series delivers even more clarity, smoother and more natural sound, greater dynamic slam, and more nuanced expression from the music.

As you climb with your customers, you'll hear progressions in metal, from Solid Long-Grain Copper to Perfect-Surface Copper+, and PSS Silver; in Geometry, from Double- to Triple-Balanced; in insulation, from Foamed-PE to FEP Air-Tubes; and in Noise-Dissipation techniques, from Metal-Layer to Carbon-Layer to Graphene/Carbon Mesh-Network and our patented Dielectric-Bias System. And finally, in our newest "Mythical" interconnects, ZERO-Tech, which eliminates the cable's characteristic impedance for an even more "invisible" sonic signature.

Throughout the line, the AQ performance-driven value system is always 100% evident. Climb until the incremental cost of the higher model is no longer the least expensive way to make the most improvement — but don't be surprised if your customers find themselves at the top of the line before reaching that point!



Angel



Pegasus



Yosemite



Black Beauty



Sydney



Yukon



Big Sur



Mackenzie



Golden Gate



Red River



Evergreen



Chicago



Dragon

ThunderBird

# Audio Interconnect Cables: Bridges & Falls

Tower and Golden Gate also available in Installer 5-Packs, page 58.

Model	Tower	Evergreen	Golden Gate	Big Sur	Sydney	Yosemite ● 72v DBS	Angel ● 72v DBS
3,5mm Male Mini							
2-Male RCA							
3,5mm Female Mini							
5 Pin DIN							
<b>Metal</b>	Solid Long-Grain Copper (LGC)		Solid Perfect-Surface Copper (PSC)	Solid Perfect-Surface Copper+ (PSC+)			Solid Perfect-Surface Silver (PSS)
<b>Geometry</b>	Asymmetrical Double-Balanced (Lower Impedance on Ground, Same Quality + and - Conductors)						
<b>Dielectric</b>	Foamed-Polyethylene				Polyethylene Air-Tubes		FEP Air-Tubes
<b>Noise-Dissipation</b>	Metal-Layer Noise-Dissipation				Carbon-Based Noise-Dissipation		
<b>Jacket</b>	Black with White Stripes PVC	Green/Black Braid	Red/Black Braid	Brown/Black Braid	Dark Gray/Black Braid	Green/Black Braid	Silver/Black Braid
<b>Termination</b>	Cold-Welded, Gold-Plated			Cold-Welded, Gold-Plated Pure Purple Copper	Cold-Welded, Direct-Silver Plated Pure Purple Copper	Cold-Welded, Direct-Silver Plated Pure Red Copper	
<b>Application</b>							
3,5mm Male Mini - 2-Male RCA				Yes			
2-Male RCA - 2-Male RCA				Yes			
3,5mm Male Mini - 3,5mm Male Mini				Yes			
3,5mm Male Mini - 3,5mm Female Mini	3m and 5m Only	No	2m and 5m Only	No	No	Yes	
3,5mm Male Mini - 5 Pin DIN						Yes	
5 Pin DIN - 5 Pin DIN						Yes	
5 Pin DIN - 2-Male RCA						Yes	
<b>Length</b>	<b>Euro Retail</b>	<b>Euro Retail</b>	<b>Euro Retail</b>	<b>Euro Retail</b>	<b>Euro Retail</b>	<b>Euro Retail</b>	<b>Euro Retail</b>
0,6m	45,95	79,00	119,00	159,00	249,00	469,00	999,00
1m	49,95	89,00	129,00	169,00	279,00	519,00	1.199,00
1,5m	54,95	99,00	139,00	185,00	319,00	579,00	1.449,00
2m	59,95	109,00	149,00	199,00	359,00	639,00	1.699,00
3m	69,95	119,00	169,00	229,00	439,00	759,00	2.199,00
5m	89,95	149,00	219,00	289,00	599,00	999,00	3.199,00
8m	119,95	209,00	279,00	379,00	839,00	1.359,00	4.699,00
12m	159,95	279,00	369,00	499,00	1.159,00	1.839,00	6.699,00
16m	199,95	349,00	459,00	619,00	1.479,00	2.319,00	8.699,00
20m	239,95	419,00	549,00	739,00	1.799,00	2.799,00	10.699,00
Other prepared lengths use formula:	-	-	-	-	-	120,00/m + 399,00	500,00/m + 699,00

# Audio Interconnect Cables: Rivers & Mythical Horses

In order to preserve ZERO-Tech's complete isolation between signal conductors, a Double-DBS pack is included for Pegasus XLR cables.



Model	Chicago	Red River		Mackenzie		Yukon		Black Beauty*		Pegasus*		
		RCA	XLR	RCA	XLR	RCA	XLR	RCA	XLR	RCA ● 72v DBS	XLR Double ● 72v DBS	
<b>Metal</b>	Solid Long-Grain Copper (LGC)	Solid Perfect-Surface Copper (PSC)		Solid Perfect-Surface Copper+ (PSC+)								
<b>Technology</b>	N/A						ZERO-Tech (No Characteristic Impedance)					
<b>Ground Reference</b>	All Cables Have Separate Ground-Reference Conductors Plus One Signal Conductor for RCA and Two for XLR											
<b>Dielectric</b>	Hard-Cell Foamed Polyethylene				Polyethylene Air-Tubes		Hard-Cell Foamed Polyethylene		Polypropylene Air-Tubes			
<b>Noise-Dissipation</b>	Metal-Layer			Carbon Mesh-Network				ZERO-Tech + Graphene/Carbon		72v DBS + ZERO-Tech Graphene/Carbon		
<b>Jacket</b>	Green/Black Braid	Red/Black Braid		Brown/Black Braid		Black/Dark Gray Braid		Black/Black Braid		Brown/Black Braid		
<b>Plug Barrels</b>	N/A											
<b>Cold-Welded Plugs</b>	Gold-Plated			Hanging-Silver over Purple Copper				Hanging-Silver over Red Copper				
<b>Length (Pair)</b>	<b>Euro Retail</b>	<b>Euro Retail</b>	<b>Euro Retail</b>	<b>Euro Retail</b>	<b>Euro Retail</b>	<b>Euro Retail</b>	<b>Euro Retail</b>	<b>Euro Retail</b>	<b>Euro Retail</b>	<b>Euro Retail</b>	<b>Euro Retail</b>	
0,5m	129,00	219,00	279,00	329,00	399,00	469,00	549,00	759,00	919,00	1.499,00	1.799,00	
0,75m	134,00	229,00	289,00	344,00	414,00	504,00	594,00	814,00	1.004,00	1.599,00	1.949,00	
1m	139,00	239,00	299,00	359,00	429,00	539,00	639,00	869,00	1.089,00	1.699,00	2.099,00	
1,5m	149,00	259,00	319,00	389,00	459,00	609,00	729,00	979,00	1.259,00	1.899,00	2.399,00	
2m	159,00	279,00	339,00	419,00	489,00	679,00	819,00	1.089,00	1.429,00	2.099,00	2.699,00	
3m	179,00	319,00	379,00	479,00	549,00	819,00	999,00	1.309,00	1.769,00	2.499,00	3.299,00	
4m	199,00	359,00	419,00	539,00	609,00	959,00	1.179,00	1.529,00	2.109,00	2.899,00	3.899,00	
5m	219,00	399,00	459,00	599,00	669,00	1.099,00	1.359,00	1.749,00	2.449,00	3.299,00	4.499,00	
6m	239,00	439,00	499,00	659,00	729,00	1.239,00	1.539,00	1.969,00	2.789,00	3.699,00	5.099,00	
7m	259,00	479,00	539,00	719,00	789,00	1.379,00	1.719,00	2.189,00	3.129,00	4.099,00	5.699,00	
For longer lengths, please use formula:	20,00/pair m + 119,00/pair	40,00/pair m + 199,00/pair	40,00/pair m + 259,00/pair	60,00/pair m + 299,00/pair	60,00/pair m + 369,00/pair	140,00/pair m + 399,00/pair	180,00/pair m + 459,00/pair	220,00/pair m + 649,00/pair	340,00/pair m + 749,00/pair	400,00/pair m + 1.299,00/pair	600,00/pair m + 1.499,00/pair	

Bulk Cables	Chicago	Red River	Mackenzie
Euro Retail per metre	10,00 (100m spool)	20,00 (100m spool)	30,00m (50m Spool)

# Audio Interconnect Cables: Mythical Creatures

In order to preserve ZERO-Tech's complete isolation between signal conductors, a Double-DBS pack is included for XLR cables.



Model	ThunderBird*		FireBird*		Dragon*	
	RCA ● 72v DBS	XLR Double ● 72v DBS	RCA ● 72v DBS	XLR Double ● 72v DBS	RCA ● 72v DBS	XLR Double ● 72v DBS
<b>Metal</b>	Solid Perfect-Surface Copper+ (PSC+)		Solid Perfect-Surface Silver (PSS)			
<b>Technology</b>	ZERO-Tech (No Characteristic Impedance), ZERO-Tech Cables do not work as turntable cables with moving coil cartridges					
<b>Dielectric</b>	FEP Air-Tubes					
<b>Noise-Dissipation</b>	ZERO-Tech + 72v DBS + Graphene/Carbon Mesh-Network				PSS Drains + ZERO-Tech + 72v DBS + Graphene/Carbon	
<b>Jacket</b>	Blue/Black Braid		Red/Black Braid		Black/Black Braid	
<b>Plug Barrels</b>	Copper-Plated RF-Draining		Silver-Plated RF-Draining			
<b>Plug Contacts</b>	Hanging-Silver over Red-Copper					
Length (Pair)	Euro Retail	Euro Retail	Euro Retail	Euro Retail	Euro Retail	Euro Retail
0,5m	2.549,00	3.399,00	4.849,00	5.999,00	7.999,00	9.749,00
0,75m	2.874,00	3.849,00	5.674,00	7.099,00	9.249,00	11.374,00
1m	3.199,00	4.299,00	6.499,00	8.199,00	10.499,00	12.999,00
1,5m	3.849,00	5.199,00	8.149,00	10.399,00	12.999,00	16.249,00
2m	4.499,00	6.099,00	9.799,00	12.599,00	15.499,00	19.499,00
2,5m	5.149,00	6.999,00	11.449,00	14.799,00	17.999,00	22.749,00
3m	5.799,00	7.899,00	13.099,00	16.999,00	20.499,00	25.999,00
4m	7.099,00	9.699,00	16.399,00	21.399,00	25.499,00	32.499,00
5m	8.399,00	11.499,00	19.699,00	25.799,00	30.499,00	38.999,00
6m	9.699,00	13.299,00	22.999,00	30.199,00	35.499,00	45.499,00
<b>Other prepared lengths, use formula:</b>	1.300,00/pair m + 1.899,00/pair	1.800,00/pair m + 2.499,00/pair	3.300,00/pair m + 3.199,00/pair	4.400,00/pair m + 3.799,00/pair	5.000,00/pair m + 5.499,00/pair	6.500,00/pair m + 6.499,00/pair

\*ZERO-Tech Cables do not work as turntable cables with moving coil cartridges.

# Audio Interconnect Accessories



**FLX-Mini Splitter**  
3,5mm Mini Male Stereo >  
(2) 3,5mm Female Stereo  
**Metal:** Solid Perfect-Surface  
Copper+ (PSC+)  
**Length:** 15cm

**Euro Retail: 29,95**



**FLX-Mini/RCA Adaptor**  
3,5mm Mini Male Stereo <>  
2 Female RCA (L & R)  
**Metal:** Solid Perfect-Surface  
Copper+ (PSC+)  
**Length:** 15cm

**Euro Retail: 29,95**



**Hard Mini/RCA Adaptor**  
Hard Mini 3,5mm Male <>  
2 Female RCA (L & R)

**Euro Retail: 19,95**



**FLX-X RCA Splitter**  
RCA Male >  
2 Female RCA (L & R)  
**Metal:** Solid Long-Grain  
Copper (LGC)  
**Length:** 15cm

**Euro Retail: 26,95**



**FLX-X RCA Splitter**  
RCA Female >  
2 Male (L & R)  
**Metal:** Solid Long-Grain  
Copper (LGC)  
**Length:** 15cm

**Euro Retail: 26,95**



**M21F-90 Adaptor**  
Female RCA to Right Angle  
Male RCA

**Euro Retail: 12,95**



**Hard RCA Splitter**  
Male RCA > 2 Female RCA

**Euro Retail: 24,95**



**RCA - RCA Coupler**  
Female RCA <> Female RCA

**Euro Retail: 13,95**



**PreAmp Jumpers**  
Solid Perfect-Surface Copper+ (PSC+) conductors in Polyethylene Air-Tubes. Replaces factory fitted "U" jumpers on integrated amps and receivers.

**Euro Retail: 54,95**

# Subwoofer Cables



Model	Black Lab	Greyhound	Irish Red	Boxer	Husky	
					RCA ● 72v DBS	XLR ● 72v DBS
<b>Metal</b>	Solid Long-Grain Copper (LGC)	0,5% Silver	Solid 0,5% Silver	Solid 1,25% Silver	Solid 5% Silver	
<b>Geometry</b>	Symmetrical Coax	HyperLitz Coax	Symmetrical Coax	Double-Balanced	Triple-Balanced	
<b>Dielectric</b>	Foamed-Polyethylene			Polyethylene Air-Tubes		
<b>Noise-Dissipation</b>	Metal-Layer Noise-Dissipation			Carbon-Based Noise-Dissipation	Carbon-Based Multi-Layer Noise-Dissipation	
<b>Jacket</b>	Black with White Stripes CL3/FT4 Rated PVC	Light Gray-Striped White CL3/FT4 Rated PVC	Up to 5m: Red/Black Braid 8m and Longer CL3/FT4 Rated: Black PVC with Red Stripes	Up to 5m: Brown/Black Braid 8m and Longer CL3/FT4 Rated: Black PVC with Brown Stripes	Blue/Black Braid or CL3/FT4 Rated Black PVC with Blue Stripes (Any Length)	
<b>Termination</b>	Cold-Welded, Gold-Plated			Cold-Welded, Hanging-Silver directly over pure Red Copper		
<b>Application - Attached Chassis-Ground Connector</b>						
<b>RCA - RCA</b>	Yes					
<b>RCA/XLR Mixed</b>	No				Yes	
<b>Meters</b>	<b>Euro Retail</b>	<b>Euro Retail</b>	<b>Euro Retail</b>	<b>Euro Retail</b>	<b>Euro Retail</b>	<b>Euro Retail</b>
2m	56,95	74,95	103,00	209,00	459,00	499,00
3m	65,95	84,95	115,00	239,00	539,00	579,00
5m	83,95	104,95	139,00	299,00	699,00	739,00
8m	110,95	134,95	175,00	389,00	939,00	979,00
12m	146,95	174,95	223,00	509,00	1.259,00	1.299,00
16m	182,95	214,95	271,00	629,00	1.579,00	1.619,00
20m	218,95	254,95	319,00	749,00	1.899,00	1.939,00
<b>Other prepared lengths use formula:</b>	-	-	-	-	80,00/m + 299,00	80,00/m + 339,00

Note: Greyhound is optimized for custom-installation projects that require its thin, discreet design. It does not include a chassis-ground connector.





## Tonearm Cables



Model	Yosemite ● 72v DBS	Angel ● 72v DBS	WEL Signature Limited Edition ● 72v DBS
<b>Metal</b>	Solid Perfect-Surface Copper+ (PSC+)	Solid Perfect-Surface Silver (PSS)	
<b>Dielectric</b>	FEP Air-Tubes		
<b>Noise-Dissipation</b>	Carbon-Based Noise-Dissipation		Carbon-Based Multi-Layer Noise-Dissipation
<b>Capacitance</b>	Less than 90pF/1,5M		
<b>Jacket</b>	Green/Black Braid	Silver/Black Braid	Gray/Black Braid
<b>Length</b>	<b>Euro Retail</b>	<b>Euro Retail</b>	<b>Euro Retail</b>
<b>1,2m</b>	<b>549,00</b>	<b>1.299,00</b>	<b>2.499,00</b>
<b>Other prepared lengths use formula:</b>	<b>120,00/m + 405,00</b>	<b>500,00/m + 699,00</b>	<b>750,00/m + 1.599,00</b>

## Turntable Cables



Model	Golden Gate	Yosemite ● 72v DBS	Angel ● 72v DBS	WEL Signature Limited Edition ● 72v DBS
<b>Metal</b>	Solid Perfect-Surface Copper (PSC)	Solid Perfect-Surface Copper+ (PSC+)	Solid Perfect-Surface Silver (PSS)	
<b>Dielectric</b>	Foamed-Polyethylene	FEP Air-Tubes		
<b>Noise-Dissipation</b>	N/A	Carbon-Based Noise-Dissipation		Carbon-Based Multi-Layer Noise-Dissipation
<b>Capacitance</b>	Less than 90pF/1,5M			
<b>Jacket</b>	Red/Black Braid	Green/Black Braid	Silver/Black Braid	Gray/Black Braid
<b>Length</b>	<b>Euro Retail</b>	<b>Euro Retail</b>	<b>Euro Retail</b>	<b>Euro Retail</b>
<b>1,2m</b>	-	<b>549,00</b>	<b>1.299,00</b>	<b>2.499,00</b>
<b>1,5m</b>	<b>139,00</b>	-	-	-



2158

pure 22 carat gold  
audioquest  
gold plated contacts

99

# Vinyl and Headphone Accessories

## GroundGoody Tonearm & Ground Wires

Unlike other ground wires that act as radio-frequency antennas, ThunderBird and Dragon GroundGoodys prevent hum while efficiently dissipating radio-frequency noise. GroundGoodys use premium conductor materials that are controlled for direction and cold-welded to Direct-Silver Plated #10 size spade lugs. Further, AudioQuest's RF/ND-Tech dissipates and cancels most induced radio-frequency noise.



**ThunderBird GroundGoody**  
Solid 6% Silver

Length	Euro Retail
0,6m	119,00
1m	139,00
1,5m	159,00
2m	179,00
3m	219,00



**Dragon GroundGoody**  
Solid Perfect-Surface Silver

Length	Euro Retail
0,6m	449,00
1m	599,00
1,5m	799,00
2m	999,00
3m	1.399,00

## Classic Anti-Static Record Brush

Highly Conductive Carbon Fibers

**Euro Retail: 17,95**



## Super-Conductive Record Brush

1 248.000 Highly Conductive Carbon Fibers with No-Resistance Path to Finger-Grip

**Euro Retail: 29,95**



## HL-5 Headshell Leads

Silk-wrapped Linear-Crystal Copper Litz Conductors

**Set of 4**

**Euro Retail: 69,95**

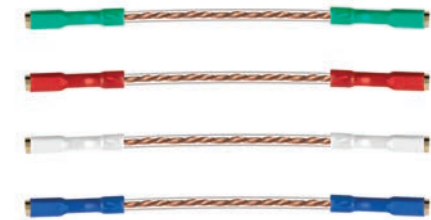

## NightBird Headphone Cable

- Fits NightHawk and NightOwl Headphones
- Perfect-Surface Copper+ (PSC+)
- Noise-Dissipation
- Robust: Tested to 28,000 bends

Length	Euro Retail
2m	109,00
3m	139,00
4m	169,00



## Headphone Plug Adaptor

- Stereo 3.5mm Female > Stereo 6,33mm (1/4") Male
- Nickel Over Extreme-Purity Brass
- Superior Materials and Firm Contact Pressure Ensure Ideal Signal Transfer

**Euro Retail: 29,95**



## Perch Headphone Stand

- Easily and safely accommodates all headphones
- High-quality materials
- Heavy base provides stability

**Euro Retail: 99,00**



# HDMI Cables

## Does AudioQuest offer the right HDMI cables for 4K TVs, 8K TVs, and beyond?

**Yes!** All of AudioQuest's new 48Gbps HDMI cables can transfer up to professional 10K Ultra-HD video. The impressive 48Gbps data rate is made possible by four balanced audio/video pairs capable of 12Gbps each. And, of course, the latest technology is backwards compatible with 4K displays.

### Video Up to 10K

AudioQuest 48Gbps HDMI cables are completely backwards compatible with existing devices and have the bandwidth required for video with resolutions up to 10K and resolutions/refresh rates up to 8K/60 and 4K/120.

### HDR (High Dynamic Range)

All AudioQuest HDMI cables support HDR (High Dynamic Range) and Dynamic HDR. HDR content expands the contrast of the image for blacker blacks and brighter whites/highlights as well as greater color saturation and brightness. In addition, 4K Ultra-HD content allows for a wider color range.

This combination of technologies results in more realistic HDR images with greater perceived depth. Dynamic HDR (HDR10+ and Dolby Vision, for example) enables frame-by-frame HDR optimization rather than HDR settings that are fixed for the entire program. The most prominent current HDR formats are HDR10, HDR10+, and Dolby Vision.

AudioQuest 18Gbps and 48Gbps HDMI cables are compatible with all varieties of HDR, which can be found on Ultra-HD Blu-ray, and all major streaming services, including Netflix, Amazon Prime, Disney+, Apple TV+, and others.

### ARC (Audio Return Channel) and eARC (enhanced Audio Return Channel)

HDMI's Audio Return Channel (ARC) sends audio from a TV to a soundbar or AV receiver for greater simplicity and flexibility in system setup. Hardware's previous ARC capabilities max out at lossy (compressed) 5.1-channel surround sound.

Today's HDMI 2.1 hardware supports enhanced Audio Return Channel (eARC), which increases the digital bandwidth dramatically to support uncompressed and lossless high-resolution multichannel audio, including Dolby TrueHD and Atmos, and DTS-HD Master Audio and DTS: X.

**8K-10K**



**eARC**

**48G<sub>bps</sub>**

Not only do all current generations of AudioQuest HDMI cables have the conductors and bandwidth required for eARC's enhanced sonic capabilities, but, in order to ensure superior audio performance, the ARC-channel conductor-pair is internally controlled for direction, running in the opposite direction from the 4 pairs that carry information to the TV.

Finally, AudioQuest's eARC-Priority models include 4 Silver-Plated Forest 48-level audio/video data pairs—but with a far superior single data pair for the TV's audio output. By upgrading the ARC data path only, audiophile quality is made possible at a fraction of the cost of upgrading all 5 data pairs.



## New Packaging

AudioQuest has turbo-charged all of its HDMI packaging with easy-to-read icons and explanations of the design and material elements that define each cable and its place in the line. Comparing, contrasting and selecting the right cable is easier than ever before.



**1.25% SILVER**

**Solid Conductors**

Solid Long-Grain Copper, Silver-Plated Copper, or Perfect-Surface Silver maximize Noise-Dissipation and overall performance.

**LEVEL 3 Carbon Mesh-Network**

**Noise Dissipation**

Six Levels of Noise-Dissipation (ND) combat distortion caused by RF Noise contaminating digital and analog circuitry.

**eARC**

**1.25% Silver Level-3 ND**

Because sound is where all the emotion and drama comes from, AQ's eARC channel gets 100% the same love as the four AV channels.

**Limited**

**Lifetime Warranty**

We've got your back. Performance backed by reliability.

**48Gbps**

**4 x 12 = 48**

The 48Gbps necessary for all of HDMI's new and future features is made possible by upgrading the 4 AV channels from 6 to 12Gbps.

## HDMI: 0,75m–5m Cables

### 18Gbps 4K and 48Gbps 8K-10K

- All models use Solid Signal and Ground-Reference Conductors.
- All 19 conductors (A/V, eARC, Ground-Reference Drains, Control, Power) are Direction-Controlled.
- AudioQuest "48" HDMI cables have the bandwidth required for video with resolutions up to 10K, resolutions/refresh rates up to 8K/60 and 4K/120.
- For long-length models (Pearl 18, Forest 18, Root Beer 18, Cherry Cola 18, and Cherry Cola 48), see page 37.

**BlueBerry 18, Pearl 48, Forest 48, and Cinnamon 48 available in Installer 5-Packs, page 59.**



Model	BlueBerry 18	Pearl 48	Forest 48	Cinnamon 48	Carbon 48	Vodka 48	ThunderBird 48	FireBird 48 ● 72v DBS	Dragon 48 ● 72v DBS
<b>A/V Conductor</b>	Solid Long-Grain Copper (LGC)		0,5% Silver	1,25% Silver	5% Silver	10% Silver	10% Silver	100% PSS Silver	100% PSS Silver
<b>eARC Conductor</b>	Solid Long-Grain Copper (LGC)		0,5% Silver	1,25% Silver	5% Silver	10% Silver	10% Silver	100% PSS Silver	100% PSS Silver
<b>Ground Reference</b>	Tinned Copper			0,5% Silver	1,25% Silver	5% Silver	10% Silver	10% Silver	100% PSS Silver
<b>Noise-Dissipation</b>	All 19 Conductors Direction-Controlled			Carbon + Metal + Direction	Carbon + Metal + Direction	Carbon + Metal + Direction	Graphene + Global Carbon + Direction	72v DBS, Graphene + Global Carbon + Direction	
<b>Jacket 0,6-2m</b>	CMG (CL3/FT4) PVC			Red Braid	Carbon Braid	Blue Braid	Blue Braid	Red Braid	Black Braid
<b>Jacket 3m</b>	CMG (CL3/FT4) PVC			Red Braid or PVC	Carbon Braid	Blue Braid	Blue Braid	Red Braid	Black Braid
<b>Jacket 5m</b>	CMG (CL3/FT4) PVC			-	-	-	-	-	-
<b>Length</b>	<b>Euro Retail</b>	<b>Euro Retail</b>	<b>Euro Retail</b>	<b>Euro Retail</b>	<b>Euro Retail</b>	<b>Euro Retail</b>	<b>Euro Retail</b>	<b>Euro Retail</b>	<b>Euro Retail</b>
0,6m	29,95	39,95	69,00	139,00	179,00	449,00	759,00	1.599,00	2.299,00
1m	34,95	44,95	79,00	159,00	199,00	519,00	899,00	1.799,00	2.699,00
1,5m	39,95	49,95	99,00	179,00	249,00	599,00	1.049,00	2.049,00	3.199,00
2m	44,95	59,95	119,00	199,00	299,00	679,00	1.199,00	2.399,00	3.699,00
3m	59,95	79,95	159,00	269,00	399,00	839,00	1.499,00	3.199,00	4.699,00
5m	99,95	199,95	299,00	449,00	-	-	-	-	-

## HDMI: Long-Length Cables

### 18Gbps 4K and 48Gbps 8K-10K

- Pearl 18 and Forest 18 employ active frequency equalization to enable 18Gbps performance for lengths up to 15m.
- Root Beer 18 active optical cable provides 18Gbps performance for lengths up to 30m.
- Certified Ultra High Speed by HDMI Licensing, Cherry Cola 48 active optical cables provide 48Gbps performance for lengths up to 50ft.



Model	Pearl 18 Long Distance	Forest 18 Long Distance	Root Beer 18 Optical	Cherry Cola 48 Optical
A/V Conductor	LGC	0,5% Silver	Quartz-Glass	Quartz-Glass
eARC Conductor	LGC	0,5% Silver	LGC	0,5% Silver
Ground Reference	Tinned Copper			0,5% Silver
Noise-Dissipation	All 19 Conductors Direction-Controlled		Galvanic Isolation + Direction	Carbon + Galvanic Isolation
Jacket	CMG (CL3/FT4) PVC			
Length	Euro Retail	Euro Retail	Euro Retail	Euro Retail
5m	-	-	469,00	999,00
7,5m	239,00	369,00	-	-
10m	289,00	459,00	549,00	1.099,00
12,5m	359,00	549,00	-	-
15m	469,00	-	619,00	1.199,00
20m	-	-	679,00	-
25m	-	-	739,00	-
30m	-	-	819,00	-

## HDMI: eARC-Priority Cables

### 48Gbps 8K-10K

- When using a TV's eARC/ARC output as the audio source to a soundbar or an A/V receiver or an amplifier's ARC input, eARC-Priority models offer their namesake models ARC performance for less than half the price of the namesake model. This is possible because the cables' unused A/V data pairs "only" offer better-than-Cinnamon 48 performance.



Model	Vodka eARC Priority 48	ThunderBird eARC Priority 48	Dragon eARC Priority 48 72v DBS
A/V Conductor	0,5% Silver	0,5% Silver	0,5% Silver
eARC Conductor	10% Silver	10% Silver	100% PSS Silver
Ground Reference	5% Silver eARC	10% Silver eARC	100% PSS Silver eARC
Noise-Dissipation	Carbon + Metal + Direction	Graphene + Global Carbon + Direction	72v DBS, Graphene + Global Carbon + Direction
Jacket 0,75-2m	Blue Braid	Blue Braid	Black Braid
Jacket 3.0m	CMG (CL3/FT4) PVC		
Length	Euro Retail	Euro Retail	Euro Retail
0,6m	219,00	459,00	1.099,00
1m	239,00	499,00	1.199,00
1,5m	269,00	549,00	1.399,00
2m	299,00	599,00	1.599,00
3m	369,00	699,00	1.999,00

# HDMI Accessories

Certain HDMI Adaptors available in Installer 5-Packs, page 59.

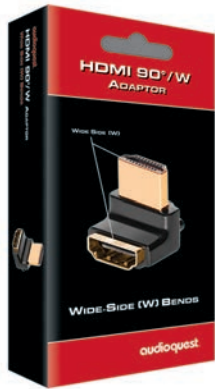

**HDMI 90°/W Adaptor**  
Wide Side [W]  
Right Angle Bend

**Euro Retail: 19,95**



**HDMI 90°/N Adaptor**  
Narrow Side [N]  
Right Angle Bend

**Euro Retail: 19,95**



**HDMI 90° NU/R Flat Adaptor**  
Narrow Up [NU]  
Bends Right

**Euro Retail: 19,95**

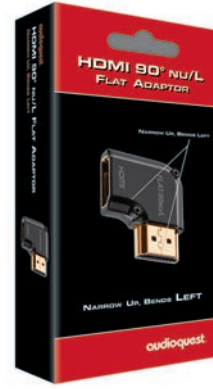

**HDMI 90° NU/L Flat Adaptor**  
Narrow Up [NU]  
Bends Left

**Euro Retail: 19,95**



**HDMI A ↔ A Coupler**  
Female HDMI to Female HDMI

**Euro Retail: 19,95**



**Mini Display Port to HDMI 4K Adaptor**

**Euro Retail: 39,95**



**DVI-IN > HDMI-OUT Adaptor**

F-DVI to M-HDMI

**Euro Retail: 39,95**



# Digital-Audio Interconnect Cables

## *Perfect Sound Forever?*

That bold statement introduced CD players to the world back in 1983. Those claiming perfection believed ones and zeros to be so beyond reproach that traditional concerns about the integrity of the playback system had become irrelevant overnight. But the CD wasn't close to perfect. Those who listened quickly figured out that the equipment and cables in the audio system mattered every bit as much as they had in the analog era.

However, to this day, stating the truth in public that digital-audio cables can make minor to even staggering differences in an audio system's performance is like yelling, "food fight" in a crowded cafeteria—you'd better get ready to duck because there will be incoming.

Yet, the same kind of music lovers and listeners who heard the CD for what it is also know that soul-satisfying digital-audio playback requires the best digital-audio cables. And the best cables reduce the most noise and distortion.

Today, there are more ways to consume digital audio than ever. Many gave up silver discs for the convenience of inferior-sounding compressed downloads, and now we've seemingly got the best of both convenience and performance: We are able to stream high-res files to our phones and mobile devices and into our homes.

AudioQuest's digital-audio cables employ all of our proven techniques for minimizing noise and distortion: better metals, better geometry, better dielectric, Dielectric-Bias System (DBS), Noise-Dissipation, Direction-Controlled Conductors, and other ingredients needed for optimizing each specific application.

The digital future is brighter and more beautiful sounding than ever...*if* your digital-audio cables are capable of treating fragile audio data as it deserves to be treated—that is, with the love and respect reserved for music.







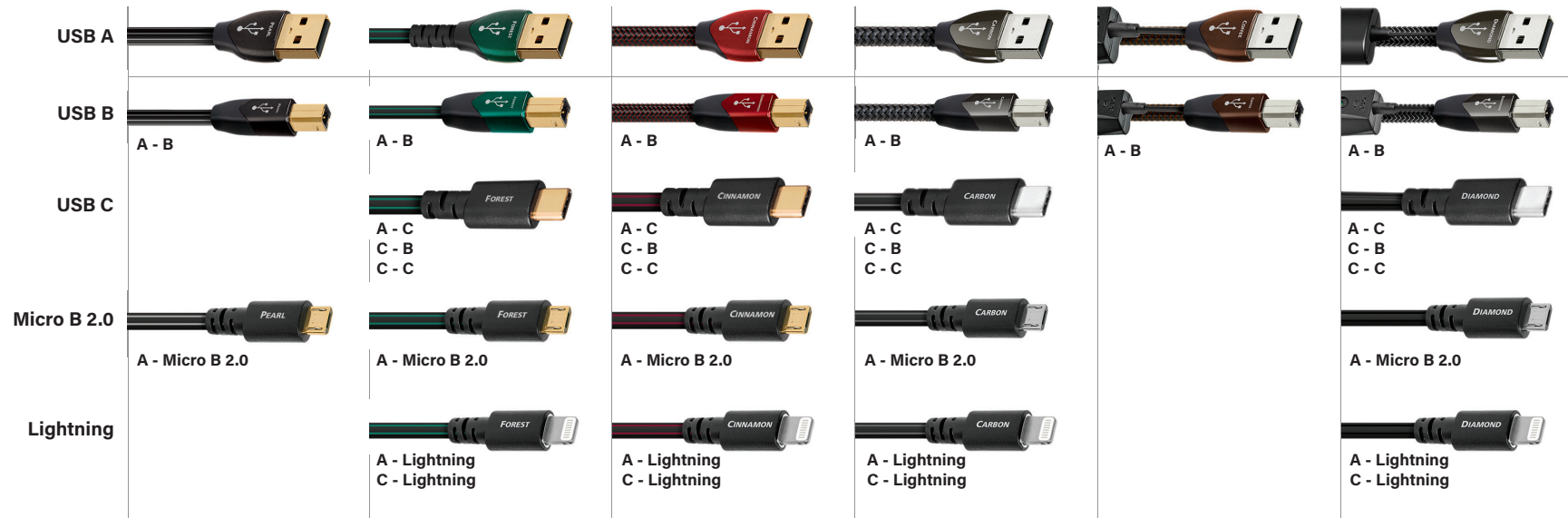





# USB Cables

All USB A - C, USB C - B, USB C - C, Micro B, and Lightning cables are available in 0,75m and 1,5m lengths only.  
For optimal sonic performance, all AudioQuest USB cables are Hi-Speed with a maximum signaling rate of 480Mbps.



Model	Pearl	Forest	Cinnamon	Carbon	Coffee ● 72v DBS	Diamond ● 72v DBS
<b>Metal (USB A-B)</b>	Solid Long-Grain Copper (LGC)	Solid 0,5% Silver	Solid 1,25% Silver	Solid 5% Silver	Solid 10% Silver	Solid 100% Perfect-Surface Silver (PSS)
<b>Metal (All Other Versions)</b>	Long-Grain Copper (LGC) Semi-Solid Concentric	0,5% Silver Semi-Solid Concentric	1,25% Silver Semi-Solid Concentric	5% Silver Semi-Solid Concentric	N/A	Solid 100% Perfect-Surface Silver (PSS)
<b>Dielectric</b>	Hard-Cell Foam					
<b>Noise-Dissipation</b>	Metal-Layer Noise-Dissipation			Carbon-Based Noise-Dissipation for USB A - B and USB 3.0 A - 3.0 Micro		
<b>Jacket</b>	Black PVC with White Stripes	Black PVC with Green Stripes	USB A-B: Red/Black Braid All others: Black PVC with Red Stripes	Gray/Black Braid	Brown/Black Braid	USB A-B: Silver/Black Braid All others: Black PVC with Silver Stripes
<b>Available Configurations</b>	<b>USB A - B</b> <b>USB A - Micro B</b>	<b>USB A - B</b> <b>USB A - C</b> <b>USB A - Micro B 2.0</b> <b>USB A - Lightning</b> <b>USB C - B</b> <b>USB C - C</b> <b>USB C - Lightning</b>	<b>USB A - B</b> <b>USB A - C</b> <b>USB A - Micro B 2.0</b> <b>USB A - Lightning</b> <b>USB C - B</b> <b>USB C - C</b> <b>USB C - Lightning</b>	<b>USB A - B</b> <b>USB A - C</b> <b>USB A - Micro B 2.0</b> <b>USB A - Lightning</b> <b>USB C - B</b> <b>USB C - C</b> <b>USB C - Lightning</b>	<b>USB A - B</b>	<b>USB A - B</b> <b>USB A - C</b> <b>USB A - Micro B 2.0</b> <b>USB A - Lightning</b> <b>USB C - B</b> <b>USB C - C</b> <b>USB C - Lightning</b>
<b>Length</b>	<b>Euro Retail</b>	<b>Euro Retail</b>	<b>Euro Retail</b>	<b>Euro Retail</b>	<b>Euro Retail</b>	<b>Euro Retail</b>
0,75m	39,95	79,00	109,00	199,00	439,00	769,00
1,5m	49,95	99,00	139,00	249,00	529,00	929,00
3m	69,95 (A-B Only)	119,00 (A-B Only)	179,00 (A-B Only)	349,00 (A-B Only)	769,00	1.259,00 (A-B Only)
5m	99,95 (A-B Only)	159,00 (A-B Only)	239,00 (A-B Only)	499,00 (A-B Only)	979,00	1.699,00 (A-B Only)

# USB Connector Applications

<p><b>USB A</b></p>   <p>For all devices that use the original USB connection.</p>	<p><b>USB B</b></p>   <p>Typically for use with computer peripherals, such as hard drives and network devices, as well as digital-audio components, including DACs and streamers.</p>	<p><b>USB C</b></p>   <p>Typically for use with newer devices, including desktops, laptops, smartphones, tablets, game consoles, hard drives, and more.</p>	<p><b>Micro B 2.0</b></p>   <p>Typically for use with compact and mobile devices, including Android smartphones and computer peripherals.</p>	<p><b>Lightning</b></p>   <p>For use with Apple devices, including iPhones and iPads.</p>
--	---	---	--	---

# USB Accessories



**USB 3.1 Gen 2 C → A Adaptor**

Euro Retail: 24,95



**USB B ↔ Micro B 2.0 Adaptor**

Euro Retail: 19,95



**USB Mini B ↔ Micro B 2.0 Adaptor**

Euro Retail: 17,95



**JitterBug FMJ**  
USB 2.0 Noise Filter (Data & Power)

Euro Retail: 69,00



# Optical Cables

Pearl, Forest, and Cinnamon available in Installer 5-Packs, page 58.



Model	Pearl	Forest	Cinnamon	Carbon	Vodka
<b>Conductors</b>	Low-Dispersion Fiber	Low-Dispersion High-Purity Fiber	Lower-Dispersion Highest-Purity Fiber	19 Narrow-Aperture Highest-Purity Synthetic Fibers	217 Narrowest-Aperture Highest-Purity Synthetic Fibers
<b>Jacket</b>	Black with Gray Stripes In-Wall Rated PVC	0,75m and 1,5m: Green/Black Braid 3m and Longer: In-Wall Rated PVC	0,75m and 1,5m: Red/Black Braid 3m and Longer: In-Wall Rated PVC	0,75m to 5m: Gray/Black Braid 8m and Longer: In-Wall Rated PVC	0,75m to 5m: Blue/Black Braid 8m and Longer: In-Wall Rated PVC
<b>Length</b>	<b>Euro Retail</b>	<b>Euro Retail</b>	<b>Euro Retail</b>	<b>Euro Retail</b>	<b>Euro Retail</b>
0,75m	34,95	54,95	79,00	139,00	269,00
1,5m	39,95	64,95	99,00	189,00	349,00
3m	59,95	99,95	149,00	269,00	549,00
5m	79,95	139,95	199,00	379,00	749,00
8m	109,95	199,95	299,00	549,00	1.099,00
12m	149,95	279,95	429,00	749,00	1.499,00
16m	189,95	359,95	549,00	949,00	1.799,00

Pearl available in both 3,5mm Mini to Full-Size, and Full-Size to Full-Size.

Forest, Cinnamon, Carbon, and Vodka come in Full-Size to Full-Size with 3,5mm Mini Adaptor included.

## Optical Accessory



**Optical Mini Adaptor**

**Euro Retail: 17,95**

# Digital Coax Cables

Forest available in Installer 5-Packs, page 59.



## RCA > BNC

Recommended for Forest through Diamond.  
Fully acceptable for Wild and WEL when BNC needed only on one end, or to keep an RCA/RCA cable universally useful.

**Euro Retail: 19,95**



Model	Forest	Cinnamon	Carbon	Coffee ● 72v DBS	Diamond ● 72v DBS	Wild ● 72v DBS	WEL Signature ● 72v DBS
<b>Metal</b>	Solid 0,5% Silver	Solid 1,25% Silver	Solid 5% Silver	Solid 10% Silver	Solid 100% Perfect-Surface Silver (PSS)		
<b>Gauge</b>	24 AWG			21 AWG			
<b>Dielectric</b>	Hard-Cell Foam						
<b>Noise-Dissipation</b>	Metal-Layer Noise-Dissipation		Carbon-Based Multi-Layer Noise-Dissipation			Carbon-Based Multi-Layer Noise-Dissipation, 2 x EMI Absorption	Carbon-Based Multi-Layer Noise-Dissipation, 3 x EMI Absorption
<b>Jacket</b>	Black PVC with Green Stripes	Red/Black Braid	Black/Dark Gray Braid	Brown/Black Braid	Silver/Black Braid	Navy Blue Braid	Black Braid
<b>Terminations</b>	Cold-Welded, Gold-Plated		Cold-Welded, Hanging-Silver Directly Over Pure Purple Copper	Cold-Welded, Hanging-Silver Directly Over Pure Red Copper		Cold-Welded, Hanging-Silver Directly Over Machined Pure Red Copper	
<b>Shield</b>	Foil + Tinned Braid	Foil + Silver-Plated Braid		Silver-Plated Braid		Copper Foil + 100% PSS-Silver Spiral	
<b>Application</b>							
<b>RCA</b>	Yes						
<b>BNC</b>	No (Requires Female RCA to Male BNC adaptor					Yes	
<b>Length</b>	<b>Euro Retail</b>	<b>Euro Retail</b>	<b>Euro Retail</b>	<b>Euro Retail</b>	<b>Euro Retail</b>	<b>Euro Retail</b>	<b>Euro Retail</b>
0,75m	44,95	89,00	249,00	649,00	1.219,00	2.500,00	3.900,00
1m	-	-	269,00	699,00	1.399,00	2.750,00	4.300,00
1,5m	54,95	109,00	309,00	799,00	1.749,00	3.250,00	5.100,00
2m	-	-	349,00	899,00	2.099,00	3.750,00	5.900,00
3m	74,95	149,00	429,00	1.099,00	2.799,00	4.750,00	7.500,00
5m	99,95	199,00	589,00	1.499,00	4.199,00	6.750,00	10.700,00
<b>Other prepared lengths use formula:</b>	-	-	80,00/m + 189,00	200,00/m + 499,00	700,00/m + 699,00	1.000,00/m + 1.750,00	1.600,00/m + 2.700,00

## AES/EBU (Balanced) Cables



Model	Carbon	Diamond ● 72v DBS	Wild ● 72v DBS	WEL Signature ● 72v DBS
<b>Metal</b>	Solid 5% Silver	Solid 100% Perfect-Surface Silver (PSS)		
<b>Gauge</b>	24 AWG	21 AWG		
<b>Dielectric</b>	Hard-Cell Foam			
<b>Noise-Dissipation</b>	Carbon-Based Multi-Layer Noise-Dissipation	Carbon-Based Multi-Layer Noise-Dissipation, 2 x EMI Absorption	Carbon-Based Multi-Layer Noise-Dissipation, 2 x EMI Absorption	Carbon-Based Multi-Layer Noise-Dissipation, 3 x EMI Absorption
<b>Jacket</b>	Dark Gray/Black Braid	Silver/Black Braid	Navy Blue Braid	Black Braid
<b>Termination</b>	Cold-Welded, Hanging-Silver Directly Over Pure Purple Copper	Cold-Welded, Hanging-Silver Directly Over Pure Red Copper	Cold-Welded, Hanging-Silver Directly Over Machined Pure Red Copper	
<b>Shield</b>	Foil + Tinned Braid		Foil + Silver-Plated Spiral	
<b>Length</b>	<b>Euro Retail</b>	<b>Euro Retail</b>	<b>Euro Retail</b>	<b>Euro Retail</b>
0,75m	289,00	1.599,00	2.900,00	4.900,00
1m	319,00	1.799,00	3.200,00	5.400,00
1,5m	379,00	2.199,00	3.800,00	6.400,00
2m	439,00	2.599,00	4.400,00	7.400,00
3m	559,00	3.399,00	5.600,00	9.400,00
5m	799,00	4.999,00	8.000,00	13.400,00
<b>Other prepared lengths use formula:</b>	<b>120,00/m + 199,00</b>	<b>800,00/m + 999,00</b>	<b>1.200,00/m + 2.000,00</b>	<b>2.000,00/m + 3.400,00</b>

# Ethernet Cables (RJ/E)

Pearl, Forest and Cinnamon available in Installer 5-Packs, page 59.



Model	Pearl	Forest	Cinnamon	Vodka	Diamond 72v DBS
<b>Metal</b>	Solid Long-Grain Copper (LGC)	Solid 0,5% Silver	Solid 1,25% Silver	Solid 10% Silver	Solid 100% Perfect-Surface Silver (PSS)
<b>Dielectric</b>	Geometry Stabilizing Solid High-Density Polyethylene				
<b>Noise-Dissipation</b>	Direction-Controlled Conductors			Carbon-Based Noise-Dissipation	
<b>Jacket</b>	CMG (CL3 & FT4) Rated Black PVC with Gray Stripes	CMG (CL3 & FT4) Rated Black PVC with Green Stripes	Up to 3,0m: Red/Black Braid 5,0m and Longer: CMG (CL3 & FT4) Rated Black PVC with Red Stripes	Up to 3,0m: Blue/Black Braid 5,0m and Longer: CMG (CL3 & FT4) Rated Black PVC with Blue Stripes	Silver/Black Braid
<b>Termination</b>	Gold-Plated Nickel Connectors with 100% Shield Coverage			Precision-Made Low-Loss Ultra-Wide Bandwidth Telegärtner Connectors with 100% Shield Coverage and Strain Relief	
<b>Length</b>	<b>Euro Retail</b>	<b>Euro Retail</b>	<b>Euro Retail</b>	<b>Euro Retail</b>	<b>Euro Retail</b>
0,75m	39,95	79,00	119,00	549,00	1.399,00
1,5m	59,95	99,00	139,00	699,00	2.199,00
3m	79,95	129,00	179,00	949,00	3.699,00
5m	119,95	169,00	239,00	1.349,00	5.399,00
8m	169,95	239,00	329,00	1.999,00	8.699,00
12m	229,95	329,00	449,00	2.749,00	12.999,00

## Accessories



### Level-X DBS Pack 72v + Noise-Dissipation

- Niagara Custom-Built Noise-Trap Dissipates RF Noise
- 72v Dielectric-Bias System Reduces Dielectric-Noise

**Euro Retail Each: 139,00**



### SorboGel Q-Feet System

Set of 4 energy-absorbing feet each with a "tray" which improves performance and protects furniture. Each foot supports up to 4 kg.

**Euro Retail: 159,00**



### Fog Lifters

For use with audio and AC power cables, Fog Lifters reduce the RF noise that capacitively couples into cables through all solid materials (carpet, stone, wood, etc.)

**Set of 8 Euro Retail: 159,00**



### Cable Clips

Fast and easy way to hold AudioQuest's largest cables in place.

#### AC Power Cables:

- Thunder, Tornado, Hurricane, FireBird, Dragon

#### Speaker Cables:

- Robin Hood, William Tell
- ThunderBird, FireBird, Dragon

#### Interconnect Cables (RCA and XLR):

- ThunderBird, FireBird, Dragon

**Set of 6 Euro Retail: 10,00**



### CleanScreen Kit

150 ml. Bottle + 10 ml. Spray + Retractable Brush

**Euro Retail: 29,95**



### Sorbothane Self-Stick Sheet

15,24cm x 15,24cm x 0,25cm sheet can be cut to size to damp anything, especially effective on top surface of speaker stands.

**Euro Retail: 54,95**



### Binding-Post Wrench

Real tool-quality double-ended nut driver with metal inserts.

Fits 11,1 mm and 12,7mm binding posts.

**Euro Retail: 19,95**



## Accessories



**RCA <> BNC Adaptor**  
Female RCA to/from Male BNC

**Euro Retail: 19,95**



**F > RCA Male Adaptor**  
Female RCA to Male RCA

**Euro Retail: 12,95**



**F > BNC Male Adaptor**  
75Ω

**Euro Retail: 19,95**



**F > 2F Splitter**  
3GHz 75Ω

**Euro Retail: 19,95**



**F > 4F Splitter**  
3GHz 75Ω

**Euro Retail: 25,95**



**F <> F**  
75Ω Coupler

**Euro Retail: 8,95**



**F-90°**  
Male <> Female Adaptor

**Euro Retail: 12,95**

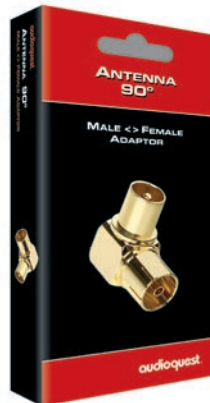

**Antenna 90°**  
Male <> Female Adaptor

**Euro Retail: 9,95**

### Antenna Cable



Model	Antenna HD6 Forest
Conductor	Solid 0,5% Silver
Shield	3-Layer Shield: Foil + 90% Braid + Foil
Jacket	Dark Gray with Green Stripes
<b>Application</b>	
Male Coax - Male Coax	Yes
Male Coax - Female Coax	Yes
Female Coax - Female Coax	Yes
F - F	Yes
<b>Length</b>	
<b>Euro Retail</b>	
1,5m	50,00
3m	65,00
4,5m	80,00

## Accessories

### RCA-300

Fits cables up to 7,0mm O.D.  
Gold-Plated. Requires soldering.



**#300 Male**  
Set of 4

Euro Retail: 60,00

**#300 Female**  
Set of 4

Euro Retail: 60,00

### RCA-800

Fits cables up to 9,0mm O.D.  
Direct-Silver Plated. Requires soldering.



**#800 Male**  
Set of 4

Euro Retail: 80,00

### XLR Connectors

Fits cables up to 9,0mm O.D.  
Direct-Silver Plated. Requires soldering.



**#81 Male**  
Pair

Euro Retail: 120,00

**#80 Female**  
Pair

Euro Retail: 120,00

### Right-Angle F and RCA Plugs

Fits cables up to 7,5mm O.D.  
Gold-Plated. Requires soldering.



**F-90°**  
Pair

Euro Retail: 50,00

**RCA-90°**  
Pair

Euro Retail: 50,00

# Accessories



**RJ45 Noise-Stopper Caps**  
 AQ Noise-Stopper Caps fit over unused RJ45 inputs or outputs, preventing RFI and EMI noise from entering the active circuit. Noise-Stopper Caps also protect against dust and corrosion.

**Set of 4**  
**Euro Retail: 34,95**



**USB-A Noise-Stopper Caps**  
 AQ Noise-Stopper Caps fit over unused USB inputs or outputs, preventing RFI and EMI noise from entering the active circuit. Noise-Stopper Caps also protect against dust and corrosion.

**Set of 4**  
**Euro Retail: 34,95**



**HDMI Noise-Stopper Caps**  
 AQ Noise-Stopper Caps fit over unused HDMI inputs or outputs, preventing RFI and EMI noise from entering the active circuit. Noise-Stopper Caps also protect against dust and corrosion.

**Set of 4**  
**Euro Retail: 34,95**

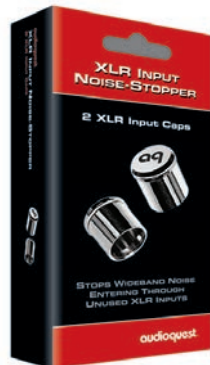

**XLR Input (Female) Noise-Stopper Caps**  
 Blocks a significant path for incoming high-frequency energy to interfere with circuit performance.

**Euro Retail**  
**per Pair: 44,95**



**XLR Output (Male) Noise-Stopper Caps**  
 Blocks a significant path for incoming high-frequency energy to interfere with circuit performance.

**Euro Retail**  
**per Pair: 44,95**

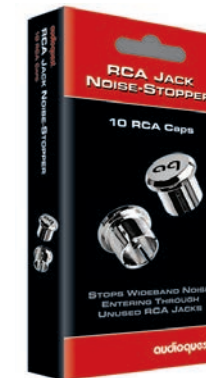







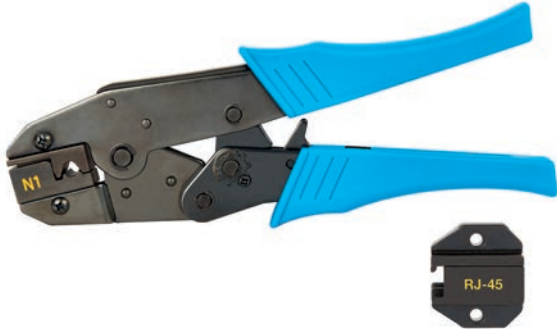

**RCA Noise-Stopper Caps**  
 Blocks a significant path for incoming high-frequency energy to interfere with circuit performance.

**Set of 10**  
**Euro Retail: 54,95**

# Tools

All the Tools necessary to Cut, Strip, Prepare, and Terminate any AudioQuest Cable

	<b>Cat6/6a/7 Crimper Tool and Die</b> Includes Cat6 and Cat 7 Die		<b>Rivers Interconnect Crimper Tool</b> Use with either AudioQuest Chicago RCA, Red River and Mackenzie RCA or XLR plugs.
	<b>Cat6 Die</b> Also sold separately		
	<b>AQ Ratchet Crimper Tool</b> For up to 8 AWG Conductors		<b>Klein Crimper Tool</b> For connectors up to 10 AWG

	
<b>Klein Cable Cutter</b>	<b>Wire Stripper/Cutter/Plier Combo Tool</b>
	
<b>Ideal Articulated Stripper</b> For 8–22 AWG Conductors	<b>Paladin Jacket Stripper</b> Cleanly and easily removes the jacket on all AudioQuest Interconnect and Speaker Cables

	<b>AQ Silver Solder</b> Easy to use. Clearly sounds better.
	<b>454g Solder</b> Euro Retail: 350,00
	<b>113.5g Solder</b> Euro Retail: 100,00

# Instant Tool-less Connectors (ITC) for Analog-Audio, Mini-Coax, and RG6 Cables on Spools

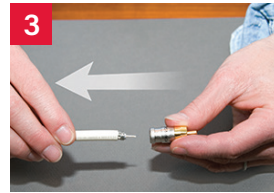
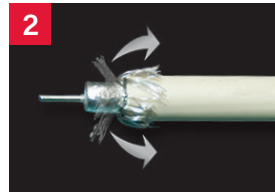

## ITC One-Step Stripper for 18 and 24 AWG

For HD6, ITA, and ITV Cables

Euro Retail: 10,00

## 18 AWG Connectors and Cables for Video, RF, Digital, Subwoofer



**ITC-18G**  
RCA  
Euro Retail  
per piece:  
3,75

Supplied in  
bags of 50



**ITC-18G**  
F  
Euro Retail  
per piece:  
3,00

Supplied in  
bags of 50



**ITC-18G**  
BNC  
Euro Retail  
per piece:  
5,50

Supplied in  
bags of 50



**ITC-18G**  
EU Coax M  
Euro Retail  
per piece:  
3,50

Supplied in  
bags of 50



**ITC-18G**  
EU Coax F  
Euro Retail  
per piece:  
3,50

Supplied in  
bags of 50

	HD6 Pearl	HD6 Forest	HD6 Carbon
<b>Metal</b>	Solid Conductive-Coated Copper	Solid 0,5% Silver	Solid 5% Silver
<b>Shield</b>	3-Layer Shield: Foil + 90% Braid + Foil		4-Layer Shield: Carbon-Loaded PE + Foil + 90% Braid + Foil
<b>CL3 Jacket Color Choices</b>	Dark Gray or White Stripes	Gray, Green or White Stripes	Black, Gray, or White Stripes
<b>Length</b>	<b>Euro Retail</b>	<b>Euro Retail</b>	<b>Euro Retail</b>
<b>76m Spool</b>	-	-	<b>20,00/m</b>
<b>152m Spool</b>	<b>6,50/m</b>	<b>10,00/m</b>	-

## 24 AWG Connectors and Cables for Analog-Audio and Video



**ITC-24G**  
RCA  
Euro Retail  
per piece:  
3,75

Supplied in  
bags of 50



**ITC-24G**  
F  
Euro Retail  
per piece:  
3,75

Supplied in  
bags of 50



**ITC-24G**  
BNC  
Euro Retail  
per piece:  
5,50

Supplied in  
bags of 50

	ITA-1/1	ITA-3/3	ITA-5/5
<b>Audio</b>			
<b>Center Conductor Metal</b>	Solid Long-Grain Copper (LGC)	Solid Perfect-Surface Copper (PSC)	Solid Perfect-Surface Copper+ (PSC+)
<b>Neg. Conductor/Shield</b>	LGC HyperLitz	PSC HyperLitz	PSC+ HyperLitz
<b>CL3 Jacket</b>	Blue (Pair)	Green (Pair)	Dark Gray (Pair)
<b>Length</b>	<b>Euro Retail</b>	<b>Euro Retail</b>	<b>Euro Retail</b>
<b>15m Spool</b>	<b>12,50/m</b>	-	-
<b>76m Spool</b>	<b>12,50/m</b>	<b>20,00/m</b>	<b>30,00/m</b>
<b>152m Spool</b>	<b>12,50/m</b>	-	-

### Color Bands for 18 and 24 AWG ITC Connectors

Silicon rubber bands fit all ITC connectors—even after they're attached to the cable—for easy cable identification. Available in bags of 20. One color per bag – no mixed colors. Available in 10 colors.

**Bag of 20**  
**Euro Retail:**  
**17,50**



# CL3/FT4 In-Wall Rated Bulk Speaker Cables

16/2 + 14/2    16/4 + 14/4



Model	SLiP-DB 16/2	SLiP-DB 16/4	SLiP-DB 14/2	SLiP-DB 14/4	SLiP XTRM 14/2	SLiP XTRM 14/4	SLiP-LSZH 16/2	SLiP-LSZH 14/2
<b>Metal</b>	Semi-Solid Concentric LGC				Semi-Solid True Concentric PSC and LGC		Semi-Solid Concentric LGC	
<b>Gauge</b>	1,31mm <sup>2</sup>		2,08mm <sup>2</sup>			1,31mm <sup>2</sup>	2,08mm <sup>2</sup>	
<b>Jacket</b>	White PVC with Silver Stripes or Gray PVC with Red Stripes				Dark Gray PVC with Blue Stripes		LSZH (Low Smoke Zero Halogen) White PVC with Silver Stripes	
<b>Length</b>	<b>Euro Retail</b>	<b>Euro Retail</b>	<b>Euro Retail</b>	<b>Euro Retail</b>	<b>Euro Retail</b>	<b>Euro Retail</b>	<b>Euro Retail</b>	<b>Euro Retail</b>
50m Spool	-	-	-	-	30,00/m	-	-	-
100m Spool	-	-	-	-	30,00/m	55,00/m	-	-
152m Spool	6,50/m	10,00/m	9,00/m	14,00/m	-	-	9,75/m	12,50/m



Model	Type 5	Rocket 11	Rocket 22	Rocket 33	Rocket 44	Rocket 88
<b>Metal</b>	Solid PSC+ Sonic-Signature Conductors and LGC	Semi-Solid Concentric LGC	Semi-Solid Concentric PSC and LGC	Solid PSC and LGC	Solid PSC+ and PSC	Solid PSC+
<b>Gauge</b>	1,65mm <sup>2</sup>	2,62mm <sup>2</sup>	3,31mm <sup>2</sup>	2,62mm <sup>2</sup>	2,62mm <sup>2</sup>	
<b>Geometry</b>	Star-Quad	Double-Spiral		Double Star-Quad		
<b>Dielectric</b>	N/A	PVC		Foamed-Polyethylene (For All Positive Conductors)		
<b>Noise-Dissipation</b>	Carbon-Based Noise-Dissipation	No		Carbon-Based Noise-Dissipation		
<b>Jacket</b>	Red Striped PVC	Black or White PVC	Black or White PVC	Black PVC with Red Stripes	Black PVC with Gloss Black Matte Stripes	Black PVC with Green Stripes
<b>Single BiWire Capable</b>	N/A	Yes				
<b>Length</b>	<b>Euro Retail</b>	<b>Euro Retail</b>	<b>Euro Retail</b>	<b>Euro Retail</b>	<b>Euro Retail</b>	<b>Euro Retail</b>
50m Spool	-	20,00/m	50,00/m	70,00/m	100,00/m	130,00/m
100m Spool	30,00/m	20,00/m	50,00/m	70,00/m	-	-

Termination "Pants" available for Type 5, Rocket 11/22/33/44/88, page 55.

## Bulk Speaker Cables — Not In-Wall Rated

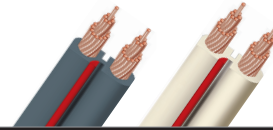
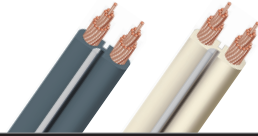

Model	G2	X2	Q2
<b>Metal</b>	Semi-Solid Concentric Long-Grain Copper (LGC)		
<b>Gauge</b>	1,31mm <sup>2</sup>	2,08mm <sup>2</sup>	1,65mm <sup>2</sup>
<b>Jacket</b>	Dark Gray PVC or Off-White PVC	Dark Gray PVC or Off-White PVC	Black PVC or White PVC
<b>Length</b>	<b>Euro Retail</b>	<b>Euro Retail</b>	<b>Euro Retail</b>
10m - <i>White Only</i>	70,00	-	-
30m Pack - <i>White Only</i>	210,00	250,00	-
100m spool	7,00/m	10,00/m	16,50/m

Note: For 100m spools, retail price per meter is listed. Other packaged lengths are shown with retail price per pack.



Model	Rocket 33	Rocket 44	Rocket 88
<b>Metal</b>	Solid Perfect-Surface Copper (PSC) and Long-Grain Copper (LGC)	Solid Perfect-Surface Copper+ (PSC+) and Perfect-Surface Copper (PSC)	Solid Perfect-Surface Copper+ (PSC+)
<b>Gauge</b>	2,62mm <sup>2</sup>	2,62mm <sup>2</sup>	
<b>Geometry</b>	Double Star-Quad		
<b>Dielectric</b>	Foamed-Polyethylene (For All Positive Conductors)		
<b>Noise-Dissipation</b>	Carbon-Based Noise-Dissipation		
<b>Jacket</b>	Red/Black Braid	Silver/Black Braid	Green/Black Braid
<b>Single BiWire Capable</b>	Yes		
<b>Length</b>	<b>Euro Retail</b>	<b>Euro Retail</b>	<b>Euro Retail</b>
50m Spool	70,00/m	100,00/m	130,00/m
100m Spool	70.00/m	-	-

Termination "Pants" available for Type 5, Rocket 33/44/88, page 55.

# SureGrip® Speaker Connectors

Fits up to 6,63mm<sup>2</sup> Speaker Cables



## SureGrip® 100 Banana

Direct-Silver or Gold over Beryllium-Copper

**Set of 8**  
**Euro Retail: 60,00**

**Set of 12**  
**Euro Retail: 90,00**

**Bag of 80**  
**Euro Retail: 600,00**

**Bag of 120**  
**Euro Retail: 900,00**



## SureGrip® 100 Multi-Spade

Direct-Silver or Gold Plating over Purple Copper

**Set of 8**  
**Euro Retail: 60,00**

**Set of 12**  
**Euro Retail: 90,00**

**Bag of 80**  
**Euro Retail: 600,00**

**Bag of 120**  
**Euro Retail: 900,00**



Allen Tool  
Included



## SureGrip® 300 Banana

Direct-Silver or Gold over Beryllium-Copper

**Set of 4**  
**Euro Retail: 60,00**

**Tray of 40**  
**Euro Retail: 600,00**



## SureGrip® 300 Multi-Spade

Direct-Silver or Gold Plating over Purple Copper

**Set of 4**  
**Euro Retail: 60,00**

**Tray of 40**  
**Euro Retail: 600,00**



Allen Tool  
Included



Black  
Labels  
Included



## 500 Series Banana or Multi-Spade

Hanging-Silver directly over pure Purple Copper or Hanging-Gold directly over pure Purple Copper. Silver or Gold.

**507** - Sized for 10,55 mm<sup>2</sup> (same as original 500 connector)

**509** - Sized for 6,63 mm<sup>2</sup>

**Set of 4**  
**Euro Retail: 129,00**

**Set of 6**  
**Euro Retail: 195,00**



Combination  
Allen and  
Phillips Tool  
Included



## 1000 Series Banana or Multi-Spade

Hanging-Silver directly over pure Red Copper.

**1003** - Sized for 26,65 mm<sup>2</sup>

**1005** - Sized for 16,76 mm<sup>2</sup>

**1007** - Sized for 10,55 mm<sup>2</sup> (same as original 1000 connector)

**1009** - Sized for 6,63 mm<sup>2</sup>

**Set of 4**  
**Euro Retail: 219,00**

**Set of 6**  
**Euro Retail: 329,00**











Combination  
Allen and  
Phillips Tool  
Included



## Spade, Pin, and Banana Connectors

Supplied with Red and Black "Boots" (except 1002)

 <p><b>1410/S 1410/G</b> Direct-Silver Plated and Direct-Gold Plated Up to 2,08 mm<sup>2</sup> 4,76mm Binding Post</p> <p><b>Set of 4</b> <b>Euro Retail: 60,00</b></p>	 <p><b>1010/S 1010/G</b> Direct-Silver Plated and Direct-Gold Plated Up to 5,26 mm<sup>2</sup> 4,76mm Binding Post</p> <p><b>Set of 4</b> <b>Euro Retail: 80,00</b></p>	 <p><b>1414/S 1414/G</b> Direct-Silver Plated and Direct-Gold Plated Up to 2,08 mm<sup>2</sup> 6,35mm Binding Post</p> <p><b>Set of 4</b> <b>Euro Retail: 60,00</b></p>
 <p><b>1014/S 1014/G</b> Direct-Silver Plated and Direct-Gold Plated Up to 5,26 mm<sup>2</sup> 6,35mm Binding Post</p> <p><b>Set of 4</b> <b>Euro Retail: 60,00</b></p>	 <p><b>1056/S 1056/G</b> Direct-Silver Plated and Direct-Gold Plated Up to 5,26 mm<sup>2</sup> 7,94mm Binding Post</p> <p><b>Set of 4</b> <b>Euro Retail: 60,00</b></p>	 <p><b>P10M/S P10M/G</b> Hanging-Silver and Hanging Gold Up to 5,26 mm<sup>2</sup> 6,35mm and 7,94mm Binding Post</p> <p><b>Set of 4</b> <b>Euro Retail: 50,00</b></p>
 <p><b>BP10/S BP10/G</b> Direct-Silver Plated and Direct-Gold Plated Up to 5,26 mm<sup>2</sup> Bendable Pin Fits Almost Everything</p> <p><b>Set of 4</b> <b>Euro Retail: 40,00</b></p>	 <p><b>Crimp-BFA/S Crimp-BFA/G</b> Direct-Silver Plated and Direct-Gold Plated Up to 6,63 mm<sup>2</sup> Standard Banana Jack</p> <p><b>Set of 4</b> <b>Euro Retail: 40,00</b></p>	 <p><b>1002/S 1002/G</b> Direct-Silver Plated and Direct-Gold Plated Up to 6,63 mm<sup>2</sup> Standard Banana Jack</p> <p><b>Set of 4</b> <b>Euro Retail: 100,00</b></p>

## Termination "Pants" for Speaker Cables



	Full-Range	Single BiWire
Model	Euro Retail	Euro Retail
Rocket 11 Pants set/4	14,95	19,95
Rocket 22 Pants set/4	14,95	19,95
Rocket 33 Pants set/4	14,95	19,95
Rocket 44 Pants set/4	14,95	19,95
Rocket 88 Pants set/4	14,95	19,95
Type 5 Pants set/4	14,95	-

# CL3/FT4 In-Wall Rated Bulk Audio Interconnect Cables & Plugs

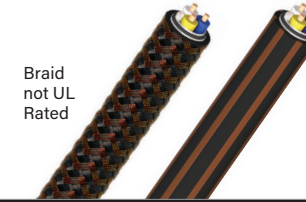
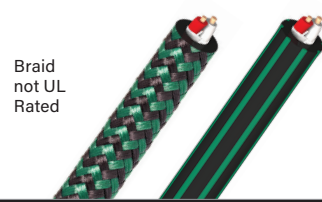

Model	Chicago	Red River	Mackenzie
<b>Metal</b>	Solid Long-Grain Copper (LGC)	Solid Perfect-Surface Copper (PSC)	Solid Perfect-Surface Copper+ (PSC+)
<b>Geometry</b>	Double-Balanced	Triple-Balanced (Separate Ground-Reference Conductor)	
<b>Dielectric</b>	Hard-Cell Foam		
<b>Noise-Dissipation</b>	Metal-Layer Noise-Dissipation		Carbon-Based Multi-Layer Noise-Dissipation
<b>Jacket</b>	Green/Black Braid or CL3 Black PVC with Green Stripes	Red/Black Braid or CL3 Black PVC with Red Stripes	Brown/Black Braid or CL3 Black PVC with Brown Stripes
<b>Length</b>	<b>Euro Retail</b>	<b>Euro Retail</b>	<b>Euro Retail</b>
50m	-	-	30,00m
100m	10,00/m	20,00/m	-

Note: For spools, retail price per meter is listed.

## Field Termination Connectors

To download Chicago, Red River, and Mackenzie cable termination manuals, go to <https://www.audioquest.com/custom-install/manuals>



### Rivers Interconnect Crimper Tool

Required with either AudioQuest Chicago RCA, Red River and Mackenzie RCA or XLR plugs.



**Chicago RCA**  
Gold-Plated

Set of 4  
Euro Retail: 89,00



**Red River RCA**  
Gold-Plated

Set of 4  
Euro Retail: 89,00



**Red River XLR**  
Gold-Plated

Set of 4  
Euro Retail: 169,00



**Mackenzie RCA**  
Hanging-Silver over Purple Copper

Set of 4  
Euro Retail: 109,00



**Mackenzie XLR**  
Hanging-Silver over Purple Copper

Set of 4  
Euro Retail: 199,00

# CL3/FT4 In-Wall Rated Bulk CAT6 and CAT7 Ethernet Cables & Plugs

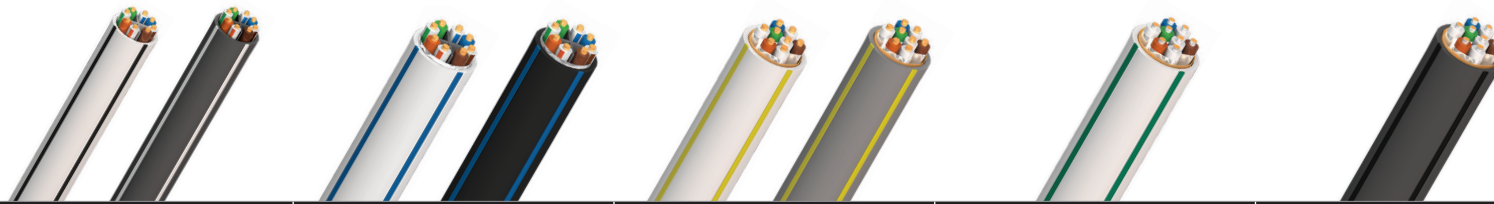

	CAT 600 DCP	CAT 600 FMJ	CAT 700 Pearl	CAT 700 Forest	CAT 700 Carbon
<b>Metal</b>	Solid Long-Grain Copper (LGC)			Solid 0,5% Silver	Solid 5% Silver
<b>Shield</b>	N/A	Overall Shield	Overall Shield and Individual Pairs		
<b>Gauge</b>	23 AWG				
<b>Dielectric</b>	Solid High-Density Polyethylene			Hard-Cell Foam	
<b>Jacket</b>	CMG (CL3/FT4) Rated White PVC with Black Stripes or Dark Gray PVC with White Stripes	CMG (CL3/FT4) Rated White or Black PVC with Blue Stripes	CMG (CL3/FT4) Rated White or Medium Gray PVC with Yellow PVC	CMG (CL3/FT4) Rated White PVC with Green Stripes	CMG (CL3/FT4) Rated Dark Gray PVC with Black Stripes
<b>Length</b>	<b>Euro Retail</b>	<b>Euro Retail</b>	<b>Euro Retail</b>	<b>Euro Retail</b>	<b>Euro Retail</b>
<b>152m</b>	-	5,00/m	10,00/m	15,00/m	65,00/m
<b>305m</b>	3,75/m	-	-	-	-

Note: For spools, retail price per meter is listed.

## CAT6/7 Connectors

To download CAT600 and CAT700 cable termination manuals, go to <https://www.audioquest.com/custom-install/manuals>



### Cat6/6a/7 Crimper Tool and Die

Required to terminate our Cat6/7 cables and connectors, includes Cat6 and Cat7 Die.



### Cat6 Die

Also sold separately



Load Bar Connector Boot

### CAT600 DCP Connectors

Fits **CAT600DCP** cable and **standard unshielded** Cat6 cables

**Each Euro**    **Bag of 50**  
**Retail: 1,75**    **Euro Retail: 87,50**



Load Bar Connector Boot

### CAT600 FMJ Connectors

Fits **CAT600FMJ**, **CAT700** and **standard shielded Cat6/Cat7** cables

**Each Euro**    **Bag of 50**  
**Retail: 3,75**    **Euro Retail: 187,50**



Load Bar Connector Boot

### CAT700 Connectors

Fits **CAT600FMJ**, **CAT700** and **standard shielded Cat6/Cat7** cables

**Each Euro**    **Bag of 50**  
**Retail: 4,00**    **Euro Retail: 200,00**



### CAT700 Telegärtner Male Connector

Fits all standard Cat6a/Cat7 cables

**Each**  
**Euro Retail: 29,50**

# Installer Packs

## Cables and Accessories in Installer-Friendly bags instead of hanging boxes.

Installer Packs provide exactly what you need to get the job done. Each Pack includes a number of high-value, high-performance AudioQuest pieces and comes with convenient integrated labels that you can peel off and place on your invoice. No retail packaging, no garbage in your truck, no excess waste or cost.

### Audio Interconnect Cables

Packs of 5



	Tower	Golden Gate	Alpha-Snake
Length	Euro Retail per Cable	Euro Retail per Cable	Euro Retail per Pair
0,5m	-	-	27,95
0,6m	45,95	119,00	-
1m	49,95	129,00	34,95
2m	59,95	149,00	39,95
3m	69,95	169,00	44,95

0,6m available in RCA - RCA only.  
1 - 3m available in RCA - RCA, 3,5mm - RCA, 3,5mm - 3,5mm.

### Optical Cables

Packs of 5



	Pearl	Forest	Cinnamon
Length	Euro Retail per Cable	Euro Retail per Cable	Euro Retail per Cable
0,75m	34,95	54,95	79,00
1,5m	39,95	64,95	99,00
3m	59,95	99,95	149,00

Available in Full-to-Full configurations only.

### Audio Interconnect FLX-X RCA Splitters

Packs of 5



M22F	F22M
Euro Retail Each	Euro Retail Each
24,95	24,95

### AC Power C7 90° Adaptors

Packs of 10



E = Equal radius	U = Unequal radius
Euro Retail Each	Euro Retail Each
22,95	22,95

### HDMI Cables

Packs of 5



	BlueBerry	Pearl 48	Forest 48
<b>Length</b>	<b>Euro Retail per Cable</b>	<b>Euro Retail per Cable</b>	<b>Euro Retail per Cable</b>
0,6m	29,95	39,95	69,00
1m	34,95	44,95	79,00
1,5m	39,95	49,95	99,00
2m	44,95	59,95	119,00
3m	59,95	79,95	159,00
5m	99,95	199,95	299,00

BlueBerry meets the 18G bandwidth required for video up to 8K/30;  
 Pearl 48, Forest 48, and Cinnamon 48 extend this capability up to 8K/60 and 4K/120.

### HDMI Adaptors

Packs of 5

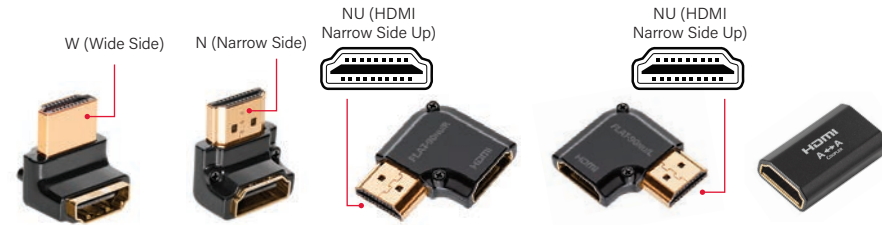

HDMI 90° /W	HDMI 90° /N	HDMI 90° NU/R	HDMI 90° NU/L	HDMI Coupler
<b>Retail Each</b>	<b>Retail Each</b>	<b>Retail Each</b>	<b>Retail Each</b>	<b>Retail Each</b>
19,95	19,95	19,95	19,95	19,95

### Ethernet Cables (RJ/E)

Packs of 5



	Pearl	Forest	Cinnamon
<b>Length</b>	<b>Euro Retail per Cable</b>	<b>Euro Retail per Cable</b>	<b>Euro Retail per Cable</b>
0,75m	39,95	79,00	119,00
1,5m	59,95	99,00	139,00
3m	79,95	119,00	179,00
5m	119,95	169,00	239,00

### Digital Coax Cables

Packs of 5



	Forest
<b>Length</b>	<b>Euro Retail per Cable</b>
0,75m	44,95
1,5m	54,95
3m	74,95
5m	99,95

# AudioQuest Branded Point of Purchase (POP) Materials



Slat Wall Sign



Acrylic Wall Sign - Red



Acrylic Wall Sign - Black



Tent Card



Window Sticker



Cube Spool Holder

Rugged metal spool holder comes with convenient merchandising labels and accommodates almost any AQ spool.



In-Store Display Rack

Spool holder sold separately.  
Dimensions: 193cm (h) x 89cm (w) x 33cm (d)



Standalone Display Rack

## AudioQuest Branded Promotional Items



### Polo Shirt

Our versatile polo shirt looks great with anything. Classic black with a discreet silver AudioQuest logo.

Men's sizes: S-2XL; Women's sizes: S-XL.



### T-Shirt

Our classic crewneck t-shirt is made from 100% lightweight, preshrunk cotton for a perfect fit that's as attractive as it is comfortable. Our t-shirt features a tasteful red AudioQuest logo against a solid black background.

Sizes: S-3XL



### Chino Washed Cotton Baseball Cap

Our baseball cap has a durable 8-stitch bill for a long-lasting, contoured shape. The Velcro fastener provides easy adjustments for a perfect fit. Available in black with red AudioQuest logo and trim, this cap looks and feels great. One size fits all.



### Beanie

Red, gray, and black, with our classic red AudioQuest logo, our stylish beanie is made from super-stretch, fine-gauge acrylic, for a warm, snug fit over your head and ears. The perfect accessory for those cooler days. One size fits all.



### Pen

Take note: With its discreet AQ logo, piano-black lacquered tube, and chrome accents, this ballpoint pen has the looks to match the quality of your prose. Keep it in your AudioQuest backpack and take it with you wherever you go.



### Water Bottle

Made by Specialized, this 769ml leak-proof water bottle has a self-sealing valve and features easy-to-squeeze BPA-free, recyclable plastic. Our distinct Wolves artwork is printed with a non-solvent based, CPSC-approved ink. Just aim and squeeze for clean, pure refreshment.

## AudioQuest Branded Promotional Items



### License Plate

It's all about the journey. Take your love for AudioQuest on the road with this license-plate frame. The clean, simple design features our red AudioQuest logo and "Experience the Difference" mantra set against a black background—perfect for any ride. Vroom!



### Backpack

Available in black with our black AudioQuest and Four Elements logos. Accommodates laptops with 13" screens and tablets. Made of nylon.



### Padded Backpack

Do no harm with our padded backpack. It features a discreet front-panel zipper, multiple internal pockets, and mesh side pockets for drinks and other items. A padded laptop insert safely accommodates screens up to 15". Mesh backing and straps are durable and comfortable, making the backpack as easy to carry as it is to wear.



### Tote Bag

This super-durable tote bag is made of water-repellent polyester and has a long strap that fits easily over a shoulder. Measuring 38cm x 36.5cm, its slim pocket is perfect for carrying AudioQuest merchandise—pens, tumblers, price books—and even an LP or two! The simple black-on-black design features a subtly stylish AQ logo.



# Index

## A

### AC Power Cables

Mistral AC Power Bulk Cable	10
NRG-X2	9
See also Installer Packs, pg. 58	
NRG-Y2	9
See also Installer Packs, pg. 58	
NRG-Z2	9
See also Installer Packs, pg. 58	
NRG-X3	9
See also Installer Packs, pg. 58	
NRG-Y3	9
See also Installer Packs, pg. 58	
NRG-Z3	9
See also Installer Packs, pg. 58	
Monsoon	10
Monsoon XTRM	10
Blizzard	10
Blizzard XTRM	10
Silver Cloud	10
Silver Cloud XTRM	10
Thunder (High-Current)	11
Tornado (High-Current)	11
Tornado (Source)	11
Hurricane (High-Current)	11
Hurricane (Source)	11
FireBird (High-Current)	11
FireBird (Source)	11
Dragon (High-Current)	11
Dragon (Source)	11

### AC Power Conditioners

PowerQuest G8	7
PowerQuest 2	7
PowerQuest 3	7
Niagara 1200	7
Niagara 3000	7
Niagara 5000	7
Niagara 7000	7

### Adaptors

C7 90° Adaptor Kit	12
See also Installer Packs, pg. 58	
DragonTail A to C Adaptor	5
DragonTail USB A 2.0 Extender	5
DragonTail USB A to Micro Adaptor	5
DVI-IN to HDMI-OUT Adaptor	38
F-90° Adaptor	47
FLX-Mini/RCA Adaptor	28
F to BNC Male Adaptor	47
F to RCA Male Adaptor	47
Hard Mini/RCA Adaptor	28

HDMI 90°/W Adaptor	38
See also Installer Packs, pg. 59	
HDMI 90°/N Adaptor	38
See also Installer Packs, pg. 59	
HDMI 90° NU/L Flat Adaptor	38
See also Installer Packs, pg. 59	
HDMI 90° NU/R Flat Adaptor	38
See also Installer Packs, pg. 59	
IEC>3US Power Strip	12
IEC90/1	12
IEC90/2	12
M21F-90 Adaptor	28
Mini Display Port to HDMI 4K Adaptor	38
Optical Mini Adaptor	42
RCA - BNC Adaptor	47
RCA to BNC	43
USB 3.1 C to A Adaptor	41
USB B - Micro B 2.0 Adaptor	41
USB Mini B - Micro B 2.0 Adaptor	41

### AES/EBU (Balanced) Cables

Carbon	44
Diamond	44
Wild	44
WEL Signature	44

### Audio Interconnect Cables

Tower	25
See also Installer Packs, pg. 58	
Evergreen	25
Golden Gate	25
See also Installer Packs, pg. 58	
Big Sur	25
Sydney	25
Yosemite	25
Angel	25
Chicago	26
See also Bulk Cables, pg. 58	
Red River	26
See also Bulk Cables, pg. 58	
Mackenzie	26
See also Bulk Cables, pg. 58	
Yukon	26
Black Beauty	26
Pegasus	26
ThunderBird	27
FireBird	27
Dragon	27
Alpha-Snake, Installer Packs	58

## B

### BiWire Jumpers

Bare Naked BiWire Jumpers	23
ThunderBird	23
Dragon	23

### Bulk Cables

HD6 Pearl	51
HD6 Forest	51
HD6 Carbon	51
ITA-1/1	51
ITA-3/3	51
ITA-5/5	51
SLiP/DB-16/2	52
SLiP/DB-16/4	52
SLiP/DB-14/2	52
SLiP/DB-14/4	52
SLiP XTRM 14/2	52
SLiP XTRM 14/4	52
G2	53
X2	53
Q2	53
Type 5	52
Rocket 11	52
Rocket 22	52
Rocket 33	53
Rocket 44	53
Rocket 88	53
Chicago	56
Mackenzie	56
Red River	56
CAT600 DCP	57
CAT600 FMJ	57
CAT700 Pearl	57
CAT700 Forest	57
CAT700 Carbon	57

## C

### Cable Clips

Cable Clips	46
-------------	----

### Cable Risers

Fog Lifters	12, 23, 46
-------------	------------

### Cleaner

CleanScreen Kit	46
-----------------	----

### Connectors

507 Series Banana	54
1000 Series Banana	54
Banana Connectors	55
CAT600 DCP Connectors	57
CAT600 FMJ Connectors	57
CAT700 Connectors	57

CAT700 Telegärtner Male Connector	57
Chicago RCA	56
Color Bands for 18 and 24 AWG ITC Connectors	51
F-90°	48
ITC-18G/BNC	51
ITC-18G/F	51
ITC-18G/RCA	51
ITC-24G/BNC	51
ITC-24G/F	51
ITC-24G/RCA	51
Mackenzie RCA	56
Mackenzie XLR	56
Pin Connectors	55
RCA-90°	48
RCA-300	48
RCA-800	48
Red River RCA	56
Red River XLR	56
Spade Connectors	55
SureGrip 100 Banana	54
SureGrip 100 Multi-Spade	54
SureGrip 300 Banana	54
SureGrip 300 Multi-Spade	54
XLR Connectors	48

## Couplers

F - F Coupler	47
HDMI A - A Coupler	38
See also Installer Packs, pg. 59	
RCA - RCA Coupler	28

## D

### DBS Pack, Level-X

### Digital Coax Cables

Forest	43
See also Installer Packs, pg. 59	
Cinnamon	43
Carbon	43
Coffee	43
Diamond	43
Wild	43
WEL Signature	43

### DragonFly

Black	5
Red	5
Cobalt	5

# Index

## E

### Ethernet Cables (RJ/E)

Pearl	45
See also Installer Packs, pg. 59	
Forest	45
See also Installer Packs, pg. 59	
Cinnamon	45
See also Installer Packs, pg. 59	
Vodka	45
Diamond	45

## F

### Fog Lifters ..... 12, 23, 46

## G

### GroundGoody

ThunderBird	33
Dragon	33

## H

### HDMI Cables

BlueBerry	36
See also Installer Packs, pg. 59	
Pearl 48	36
See also Installer Packs, pg. 59	
Forest 48	36
See also Installer Packs, pg. 59	
Cinnamon 48	36
Carbon 48	36
Vodka 48	36
ThunderBird 48	36
FireBird 48	36
Dragon 48	36
Pearl 18 Long Distance	37
Forest 18 Long Distance	37
Root Beer 18 Optical	37
Cherry Cola 48 Optical	37
Vodka eARC	37
ThunderBird eARC	37
Dragon eARC	37

### Headphone Accessories

Headphone Plug Adaptor	33
HL-5 Headshell Leads	33
NightBird Headphone Cable	33
Perch Headphone Stand	33

## J

JitterBug FMJ	5
See also USB Accessories, pg. 41	

## N

### Noise-Stopper Caps

HDMI Noise-Stopper Caps	49
RCA Noise-Stopper Caps	49
RJ45 Noise-Stopper Caps	49
USB-A Noise-Stopper Caps	49
XLR Input (Female) Noise-Stopper Caps	49
XLR Output (Male) Noise-Stopper Caps	49

## O

### Optical Cables

Pearl	42
Forest	42
Cinnamon	42
Carbon	42
Vodka	42

## P

### POP Materials

Acrylic Wall Sign - Black, Red	60
Cube Spool Holder	60
Display Rack, In-Store	60
Display Rack, Standalone	60
Slat Wall Sign	60
Tent Card	60
Window Sticker	60

### PreAmp Jumpers ..... 28

### Promotional Items

Backpack	62
Backpack, Padded	62
Baseball Cap	61
Beanie	61
Hooded Jacket	61
License Plate	62
Pen	61
Polo Shirt	61
Tote Bag	62
T-Shirt	61
Tumbler	61
Water Bottle	61

## Q

### Q-Feet, SorboGel ..... 46

## R

### Record Brushes

Classic Anti-Static Record Brush	33
Super-Conductive Record Brush	33

## S

### Solder, Silver ..... 50

### Sorbothane Self-Stick Sheet ..... 46

### Speaker Cables

Q2	16
See also Bulk Cables, pg. 53	
Type 5	16
See also Bulk Cables, pg. 52	
Type 9	16
Type 9+DBS	16
Rocket 11	17
See also Bulk Cables, pg. 52	
Rocket 22	17
See also Bulk Cables, pg. 52	
Rocket 33	17
See also Bulk Cables, pgs. 52, 53	
Rocket 44	17
See also Bulk Cables, pgs. 52, 53	
Rocket 88	17
See also Bulk Cables, pgs. 52, 53	
Robin Hood ZERO	18
Robin Hood BASS	18
Robin Hood ZERO BiWire COMBO	1
Robin Hood SILVER	18
Robin Hood SILVER BiWire COMBO	18
William Tell ZERO	19
William Tell BASS	19
William Tell ZERO BiWire COMBO	19
William Tell SILVER	19
William Tell SILVER BiWire COMBO	19
ThunderBird ZERO	20
ThunderBird BASS	20
ThunderBird ZERO BiWire COMBO	20
FireBird ZERO	21
FireBird BASS	21
FireBird BiWire COMBO	21
Dragon ZERO	22
Dragon BASS	22
Dragon BiWire COMBO	22

### Splitters

FLX-Mini Splitter	28
FLX-X RCA Splitter	28
See also Installer Packs, pg. 58	
F to 2F Splitter	47
F to 4F Splitter	47
Hard RCA Splitter	28

### Subwoofer Cables

Black Lab	29
Greyhound	29
Irish Red	29
Boxer	29
Husky	29

## T

### Termination Pants

Rocket 11	55
Rocket 22	55
Rocket 33	55
Rocket 44	55
Rocket 88	55
Type 5	55
Type 9	55

### Tonearm Cables

Golden Gate	31
Yosemite	31
Angel	31
WEL Signature Limited Edition	31

### Tools

AQ Ratchet Crimper Tool	50
Binding-Post Wrench	47
Cat6/6a/7 Crimper Tool and Die	50, 57
Cat6 Die	50, 57
Ideal Articulated Stripper	50
ITC One-Step Stripper for 18 and 24 AWG	51
Klein Cable Cutter	50
Klein Crimper Tool	50
Paladin Jacket Stripper	50
Rivers Interconnect Crimper Tool	50, 56
Wire Stripper/Cutter/Plier Combo Tool	50

### Turntable Cables

Golden Gate	31
Yosemite	31
Angel	31

## U

### USB Cables

Pearl	40
Forest	40
Cinnamon	40
Carbon	40
Coffee	40
Diamond	40



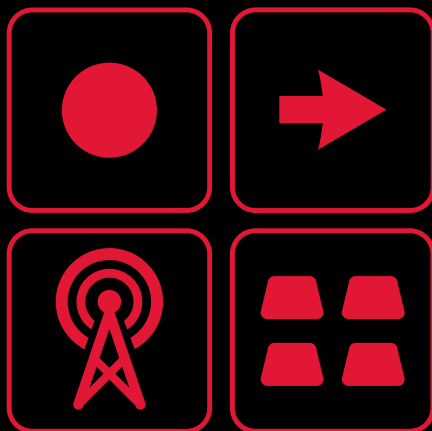

**audioquest®**

**[www.audioquest.com](http://www.audioquest.com)**

**Tel +31 165 54 1404**